

BARLOW TYRIE
quality since 1920





1MOA 1MO 1MO15 2MO15

contents

heritage	2
materials	4
teak collection	6
stainless steel collection	62
aluminium collection	94
woven collection	108
parasols & pavilions	134
specifications	146
materials selection	173
covers	179
inscriptions	180
product care	182
faqs	183

heritage

Barlow Tyrie is associated the world over with outdoor leisure furniture that strikes the highest notes in quality and style.

Since 1920, we have remained a family business that specializes in the manufacture of teak furniture to which we have now added furniture in hand-woven synthetic fibre, stainless steel and aluminium.

The pages of this catalogue present our widest ever choice of contemporary and traditional designs for the outdoor room. Our designers have combined pleasing designs with ergonomic performance to create furniture that opens life outdoors to a world of stylish possibilities.

armchairs • seats • benches • dining tables • tree seats • sun loungers • folding chairs • coffee tables

Through our commitment to produce the world's finest outdoor leisure furniture, we remain at the forefront of this rapidly changing industry and continue to demonstrate the best in British design and manufacturing expertise.

Thank you for choosing Barlow Tyrie and be assured that our customer service and after care match the excellence of our furniture.

We proudly welcome you into the elite group of owners of our furniture and look forward to being of service to you.

materials



Barlow Tyrie uses first grade plantation grown teakwood (*Tectona Grandis*), obtained from the most reputable, legal source in Indonesia.

With time, teak acquires a silver grey patina that complements any outdoor setting.

The high oil content of the teakwood used in our furniture enables it to withstand the harshest weather conditions with a minimum of maintenance. Teak is very stable and resistant to rot, which has made it the first choice for marine and outdoor use over the centuries.



We use two grades of stainless steel; 316 Grade, commonly known as 'marine grade' and 304 Grade, more commonly used for garden furniture.

Both 316 and 304 are hardwearing and suitable for use in inland locations whilst 316 is for use in coastal areas, marine and heavily chlorinated environments, where oxidation could be a problem.

You should note that all outdoor furniture, including stainless steel, requires some maintenance.

If you have any questions or concerns about the grade that is best for your area, then please contact your supplier or our customer service department.



For our aluminium furniture, we use 'Virgin Aluminium,' which means it is not reclaimed and is stronger and longer lasting as a consequence.

We chemically clean the aluminium and then powder-coat it to prevent oxidation and to ensure it gives long service with the minimum of maintenance.



We introduced our comprehensive woven ranges in recent years, since then they have become very popular.

We use the finest synthetic material that is hand-woven over a powder coated aluminium frame to produce splendid furniture that is strong, colour fast and entirely resistant to sun and rain.

Textilene® is woven from a PVC coated polyester, non-stretch yarn, which is strong and mildew resistant.

We use Textilene® for the fabric slings on our teak, stainless steel and aluminium furniture to incorporate colour, comfort and weather resistance.

Our range of luxury cushions adds that personal touch to your furniture. We use Sunbrella® fabric, made from 100% solution dyed acrylic fibre that is colourfast and resistant to mildew.

Our cushions are available in a range of outstanding solid colours and stripes.

The best furniture deserves only the very best cushions.



teak







1ADA p.148
1ADFR p.148
2AD p.148



adirondack





Quadri Grey



Lead Chiné

Reversible Slip Over Armchair Cushion
in Quadri Grey and Lead Chiné.
Ref. 800087.9998

1APA p.148

1APA p.148
2APX39 p.35 p.148

apex



1ASC p.148
1AS p.148
1ASF5 p.148
2AS11 p.149

ascot

1ASC p.148
2AR18 p.158





ascot



1ASR p.148
2ARX28 p.158





1CAS p.149



1CO p.149

commodore







1FEA p.150

1FEA p.150
2BA13 p.159
4VE30C.306 p.142

felsted



1HADA p.150
1HAO p.150

haven

1HADA p.150
1HADMC p.151
1HADML p.150
1HADMR p.150
1HADMM p.151
1HAO p.150







1GLA p.150
2COL p.161

1GLA p.151
1FEFS p.150
2AR24 p.158

glenham



1GLJA p.151
1GLJ2 p.151
2CAJ p.151

glenham







glenham



1HOF.504 p.153

horizon







1HOAST p.153

horizon



1HOAS.500 p.153

horizon







1HOR.504 p.153





1HOL.501 p.153
1HOL.502 p.153
1HOL.504 p.153
1HOL.500 p.153

1HOL.500 p.153
1LSS.500 p.153

horizon



1UA p.154

linear







1LOA p.154
2COL p.161
3ST p.161



1MOA p.155
2COL p.161

monaco

1MOA p.155
1MO p.155
2WIX23 p.160
1MO15 p.155







1MOCF p.155

1MOF p.155
1MOCF p.155
2WIC15 p.160

monaco



mondaco





1MOL p.156

monaco

mission

1MIA p.155
4SO35C.308 p.144







1RO18 p.157



1SA.201 p.157
1SAT p.157

safari





ISI p.157

sissinghurst



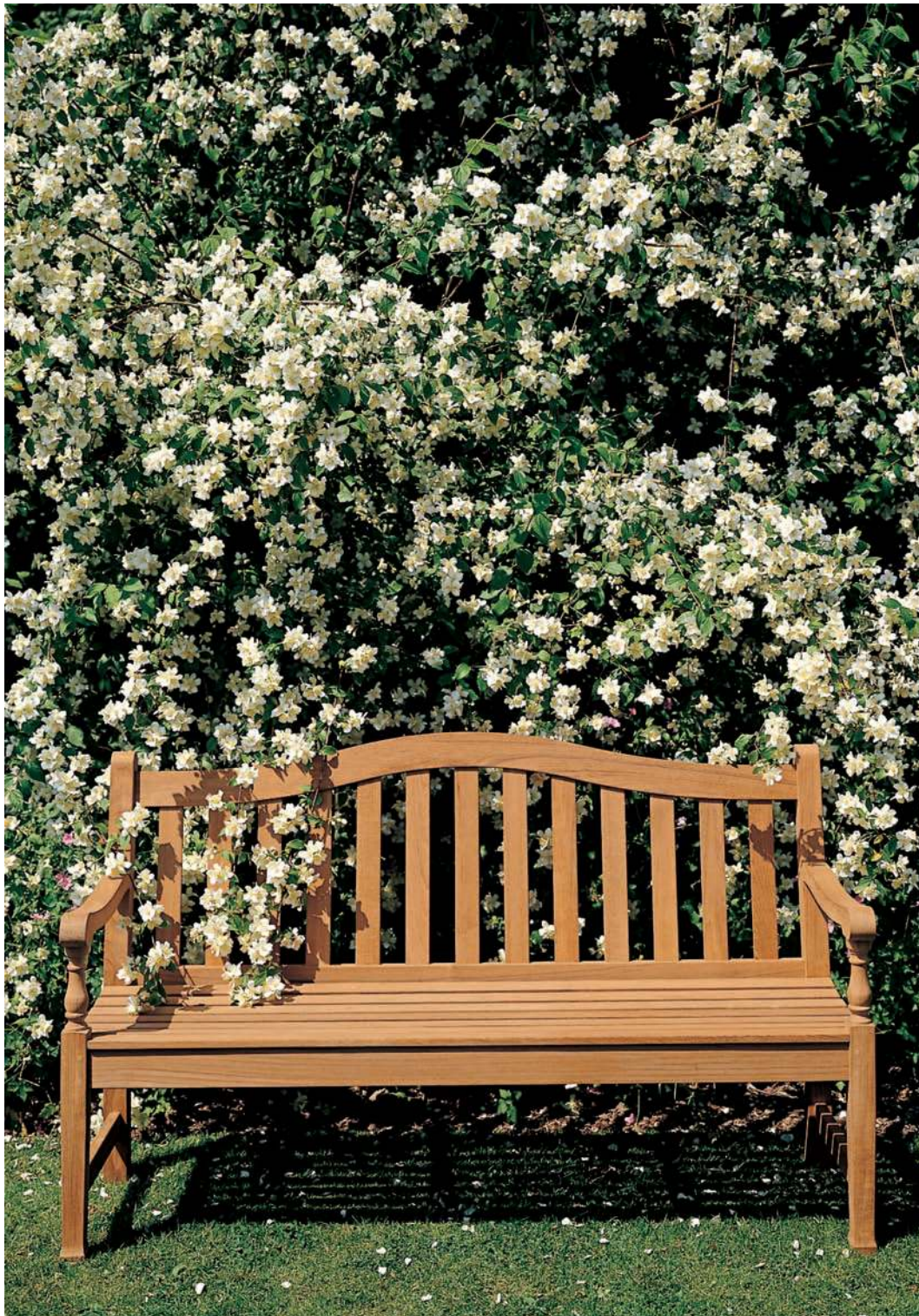

1WA15 p.158

waveney



accessories



storage chests

3SC15 p.161



reims

3RE p.161



crichton

2CR p.161



serving tray

3ST p.161

accessories



caisse versailles

3CV45 p.161



wimbledon

1W12 p.158
1W15 p.158
1W18 p.158



1NER p.156

newport

stainless steel





1EQ.T p.162
1EQA.T p.162
2EQC10 p.164

equinox

1EQ.T p.162
1EQA.T p.162
1EQ13 p.162
2EQ15 p.163
2EQL06 p.163





equinox



1EQA.504 p.162
2EQ10 p.163



1EQA.501 p.162
2EQC07 p.164

equinox

1EQA.500 p.162
2EQC15S p.164







1EQA.01.500 p.162
2EQC18.700 p.165



1EQA.504 p.162
2EQ20.700 p.165

equinox

1MEA.01.500 p.166
2EQ09.700 p.165







1EQLT p.163



equinox



1EQL.504 p.162
2EQLT p.163
4SI30C.306 p.144





1EQHC.T p.162
1EQH.T p.162
2EQS p.163

1EQHS.T p.162
1EQHC.T p.162

equinox



equinox



1EQDA p.165
1EQDO p.165
1EQD2 p.165
1EQD3 p.165



1MEA.01.500 p.166
2EQC18S p.164

mercury

1MEA.504 p.166
2EQX23 p.164







1MEA.500 p.166

1MEA.02.503 p.166
2ME22.604 p.166

mercury



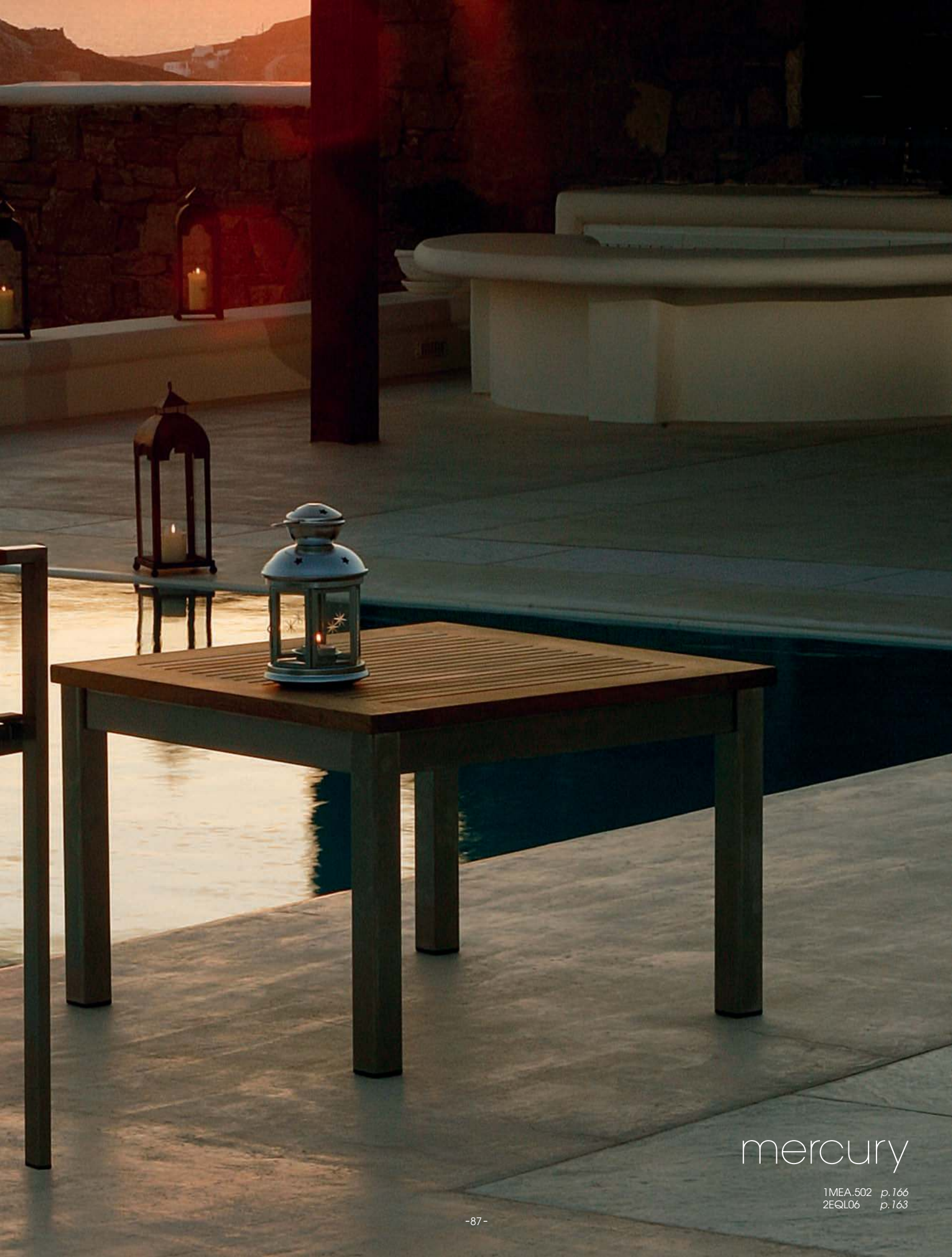

mercury

1MEA.502 p.166
2EQL06 p.163





1. Scratchproof work surface
2. Cutlery and accessories drawers
3. Serving trays
4. Condiment racks
5. Positioning wheels

mercury



1QUA.504 p.166
2QU20.700 p.167

quattro

1QUA.01.500 p.166
2QU10.700 p.167







1QUL.504 p.156

1QUL.504 p.166
2QULT p.166
1LSS.504 p.166

quattro

aluminium







1AUA.01.500 p.167
2AU09.01 p.167

1AUA.01.504 p.167
2AU15.01 p.167

aura



1ECA.03.504 p.167
2ECC12.03 p.167

eclipse

1ECA.03.504 p.167
2ECC12.03 p.168





eclipse



1ECA.01.500 p.167
2ECC12.01 p.168



1ECA.02.501 p.167
2EC20.02 p.168

eclipse

1ECL.01.500 p.167
2ECLT.01 p.167





1LPA.01.500 p.168

loop

1LPA.01.500 p.168
2LP16.01 p.168







Optional lounge armrests
available in the following
colours:

1LPLA.01 = Graphite
1LPLA.02 = Arctic White
1LPLA.03 = Quicksilver

woven









601355 p.169
601350 p.169

601361 p.169
601360 p.169
601364 p.169
601365 p.169
601366 p.169
601367 (x3) p.169
601660 p.169
603470 (x2) p.171

arizona



601650 p.169
601354 p.169
601355 p.169
601356 p.169
601357 (x2) p.169



arizona



601361 p.169

arizona

- 601361 (x2) p.169
- 601360 p.169
- 601364 p.169
- 601365 p.169
- 601367 (x2) p.169
- 601366 p.169
- 601662 p.169
- 601661 p.169







602700 p.170



602361 (x2) p.170
602660 p.170

dune

602362 p.170
602660 p.170







605100 p.170



605351 p.170
605350 p.170

nevada

605351 p.170
605350 p.170
605353 p.170
2COL p.161





605470 p.171

nevada







603100 p.171
603524 p.172



603100 (x2) p.171
603171 (x6) p.171
603565 p.172



savannah



603351 p.171

savannah

- 603351 p.171
- 603350 p.171
- 603352 p.171
- 603353 p.171
- 603651 p.172
- 603670 p.172







603470 p.172

603470 p.172
603700 p.172
4VE30C.306 p.142

savannah

pavilions & parasols

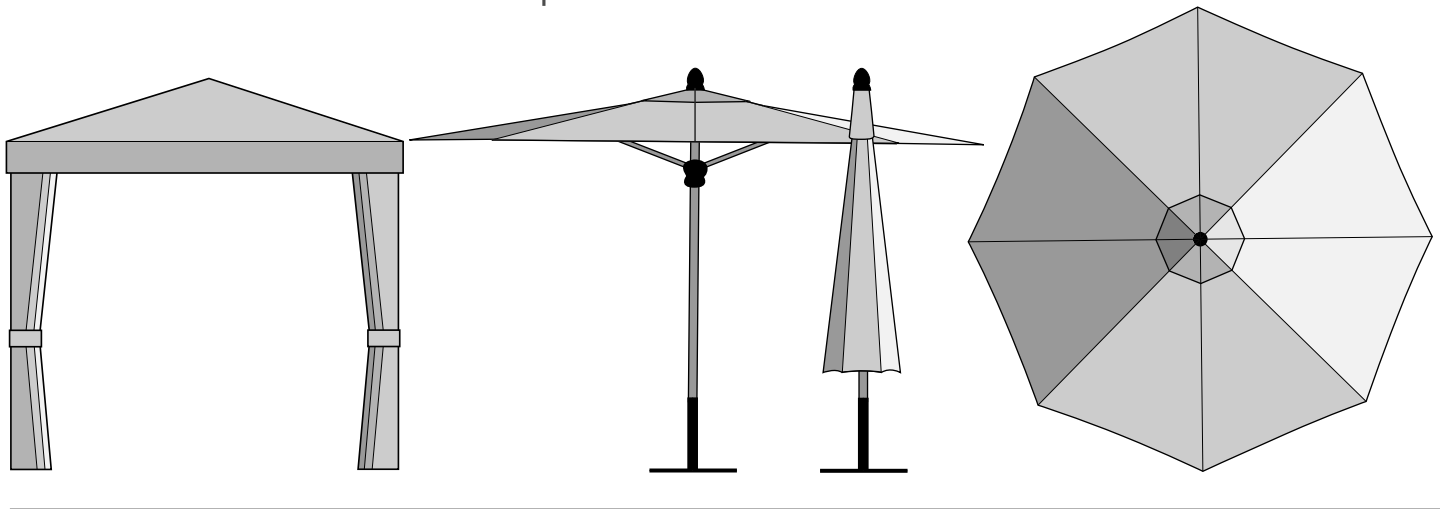

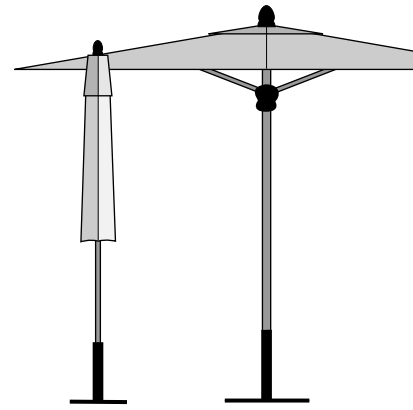
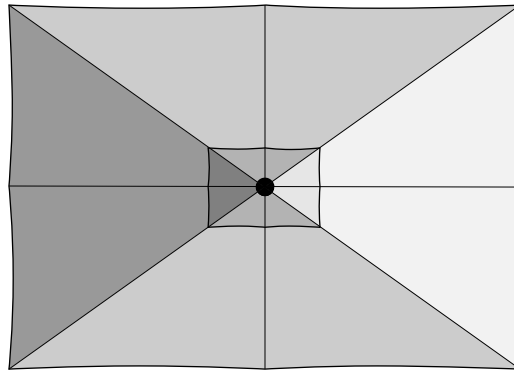
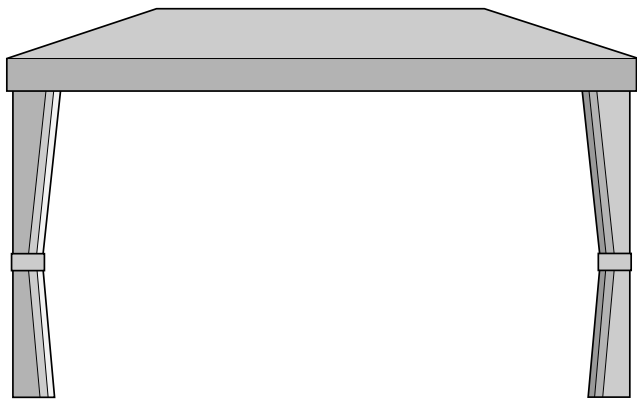

Our parasol canopy fabric is made from 100% solution-dyed acrylic yarn. The colour locks deep inside the yarn to give excellent resistance to the fading often caused by sunlight and cleaning.

The fabric has a stain repellent applied to make cleaning easier, which you should re-apply after cleaning.

We recommend that you clean the canopy regularly to prevent the accumulation of dirt in the fabric, which can encourage the growth of mildew.

All Barlow Tyrie parasols will close over our standard height dining tables that have parasol holes, except our High Dining Tables.

Pavilions are permanent structures made from the highest quality heavy duty aluminium, with the roof and full curtains from Sunbrella® fabric, which is woven from 100% solution-dyed acrylic yarn.

For areas which experience heavy snow fall, do not allow snow or ice to accumulate on the Pavilion roof as this may cause structural damage.





pavilions







9111210.4781 p.140
Cabrio

- 9011215.4642 p.140
- 601350 p.169
- 601351 p.169
- 601354 p.169
- 601355 p.169
- 601356 p.169
- 601357 x2 p.169
- 601651 p.169

pavilions

pavilions

Fixed Roof
9011210

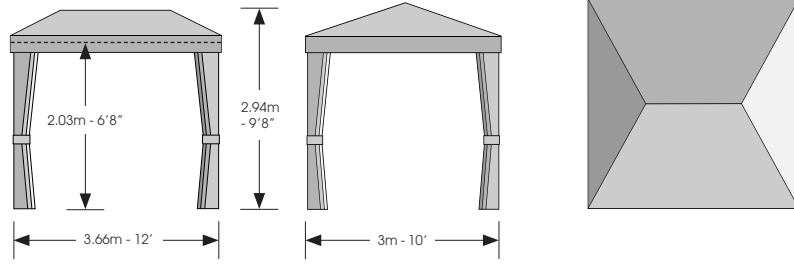

Anchoring the Pavilion

For safety, Pavilions should always be securely fastened to the ground.

See assembly instructions for details of various securing methods.

The Permo Lock anchoring system is the recommended method that offers a strong permanent solution for anchoring your Pavilion and to protect it against the wind.

913010 Permo® Lock Anchoring System

Other ground fixing accessories available
913010 For Wood Floors
913011 For Stone Floors

Fixed Roof
9011215

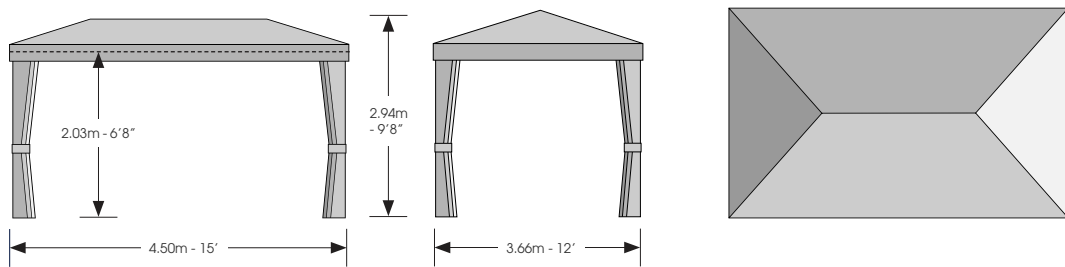

Fixed Roof
9011220

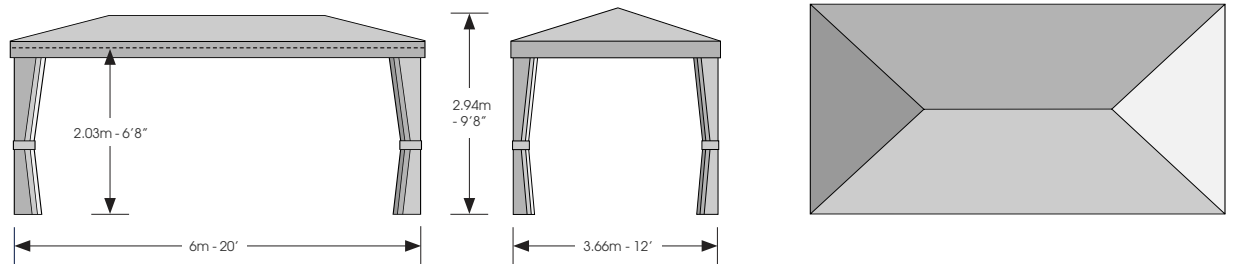

Cabrio
Opening Roof
9111210

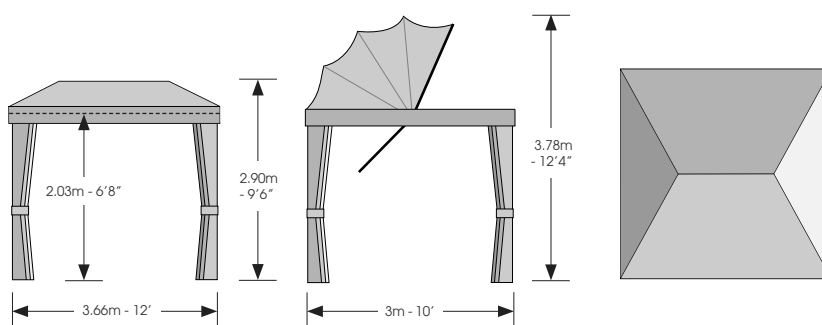

Colour Selector - Suggested Combinations

For colour reference please see page 176

The frame is made from heavy duty aluminium with the roof and full curtains from Sunbrella® fabric, which is woven using 100% solution dyed acrylic fibre that does not fade when exposed to strong sunlight.

.1275 Stone .4781 Chocolate 4642 Oyster .0001 White .0002 Silver

Fixed Roof								
Frame 3.66 x 3.00m - 12' x 10'	required		9011210		9011210		9011210	
Sunbrella Roof	required		9021210.1275	Stone	9021210.4781	Chocolate	9021210.4642	Oyster
Corner Dressing	required		909010.1275	Stone	909010.4642	Oyster	909010.4642	Oyster
Corner Ties x4	required		909050.1275	Stone	909050.4781	Chocolate	909050.4642	Oyster
Mesh Curtains x4	optional		9041210.4651	Silver	9041210.4781	Chocolate	9041210.4604	White
Sunbrella Curtains x4	optional		9031210.1275	Stone	9031210.4781	Chocolate	9031210.4642	Oyster
Sheer Panels x8	optional		909080.0002	Silver	909080.0001	White	909080.0001	White
Fixed Roof								
Frame 3.66 x 4.50m - 12' x 15'	required		9011215		9011215		9011215	
Sunbrella Roof	required		9021215.1275	Stone	9021215.4781	Chocolate	9021215.4642	Oyster
Corner Dressing	required		909020.1275	Stone	909020.4642	Oyster	909020.4642	Oyster
Corner Ties x4	required		909050.1275	Stone	909050.4781	Chocolate	909050.4642	Oyster
Mesh Curtains x4	optional		9041215.4651	Silver	9041215.4781	Chocolate	9041215.4604	White
Sunbrella Curtains x4	optional		9031215.1275	Stone	9031215.4781	Chocolate	9031215.4642	Oyster
Sheer Panels x8	optional		909080.0002	Silver	909080.0001	White	909080.0001	White
Fixed Roof								
Frame 3.66 x 6.00m - 12' x 20'	required		9011220		9011220		9011220	
Sunbrella Roof	required		9021220.1275	Stone	9021220.4781	Chocolate	9021220.4642	Oyster
Corner Dressing	required		909020.1275	Stone	909020.4642	Oyster	909020.4642	Oyster
Corner Ties x4	required		909050.1275	Stone	909050.4781	Chocolate	909050.4642	Oyster
Mesh Curtains x4	optional		9041220.4651	Silver	9041220.4781	Chocolate	9041220.4604	White
Sunbrella Curtains x4	optional		9031220.1275	Stone	9031220.4781	Chocolate	9031220.4642	Oyster
Sheer Panels x8	optional		909080.0002	Silver	909080.0001	White	909080.0001	White
Cabrio - Opening Roof								
Frame 3.66 x 3.00m - 12' x 10'	required		9111210		9111210		9111210	
Sunbrella Roof	required		9121210.1275	Stone	9121210.4781	Chocolate	9121210.4642	Oyster
Corner Dressing	required		909020.1275	Stone	909020.4642	Oyster	909020.4642	Oyster
Corner Ties x4	required		909050.1275	Stone	909050.4781	Chocolate	909050.4642	Oyster
Mesh Curtains x4	optional		9041210.4651	Silver	9041210.4781	Chocolate	9041210.4604	White
Sunbrella Curtains x4	optional		9031210.1275	Stone	9031210.4781	Chocolate	9031210.4642	Oyster
Sheer Panels x8	optional		909080.0002	Silver	909080.0001	White	909080.0001	White

If Sunbrella® Curtains are chosen then Corner Dressing and Corner Ties are not required.

Only one set of curtains can be used on the 12 x 10 Pavilion whilst both sets can be used on the 12 x 15 and 12 x 20 Pavilions

features



**Sunbrella®
Curtains**
(optional)

Curtains that give maximum protection, complete privacy and can be fully closed with a zip.



Sheer Panels
(optional)

A perfect way to add ambience to your entertaining, a sheer, light screen that adds movement in the breeze or can be used to shield the sun.



Mesh Curtains
(optional)

Provides a see through shield from the elements and can be fully closed with a zip. The curtains may be drawn on just one or two sides to provide shelter from the wind or strong sunshine.



**Heating and
Lighting**
(optional)

This infrared short-wave radiant heater instantly provides comfortable heat as soon as it is switched on. The integrated lighting units may be rotated 180°.

(This design is not available in the USA)



**Corner
Dressing**

Dresses the four corner posts but are not required if the Pavilion has Sunbrella® curtains.

Corner Ties

Used to tie back the Corner Dressing or curtains if fitted



Cabrio Roof
(optional)

An optional folding Cabrio roof, which can be opened to allow in the sun; available on the 3.66 x 3.00m - 12' x 10' pavilion only.

siena
4SI25C

With chrome fittings.
Suitable for the following tables:

- Arundel 2AR09
- Aura 2AU09
- Ascot 2AS11
- Balmoral 2BA11
- Eclipse 2ECC12
- Edinburgh 2ED09
- 2EDH09
- Equinox 2EQ09.700
- 2EQ10
- 2EQC07
- 2EQC10
- 2EQCH07
- 2EQCH10
- Haven 2HASC10
- 2HACC10
- Meizo 2ME09T
- Savannah 603522
- 603524

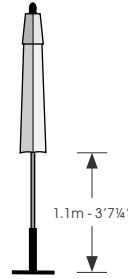
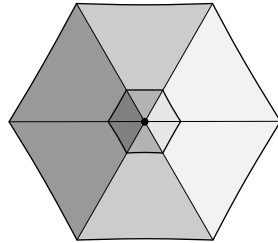
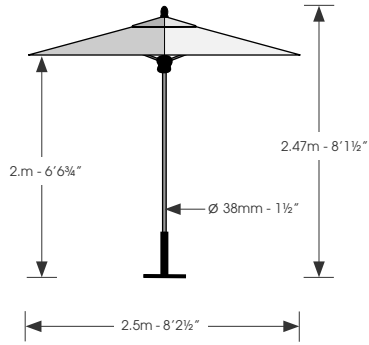

Optional Extras



Parasol Pole Reducer Ring
To remove movement between table top and pole
Brass - 4PR.38
Stainless Steel - 4PRSS.38



Parasol Base Required
Standard - 4PBS
Free Standing - 4PBFP + 4PBFTS

verona
4VE30C

With chrome fittings.
Suitable for the following tables:

- Ascot 2AS13
- Balmoral 2BA13
- Drummond 2DR15
- Edinburgh 2EDH09
- Equinox 2EQ15.700
- Haven 2HASC10
- 2HACC10
- Horizon 2HOC15
- Windsor 2WI12
- 2WIC15

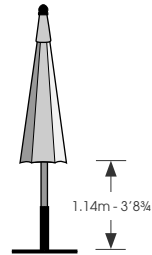
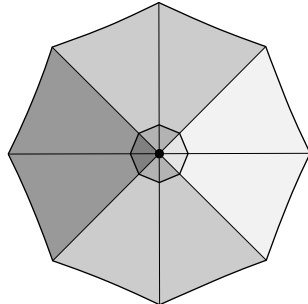
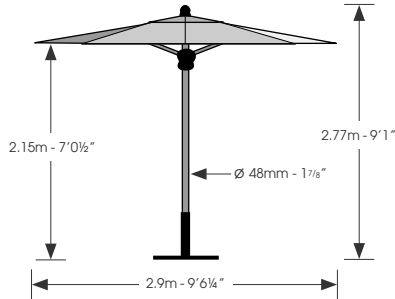

Optional Extras



Parasol Pole Reducer Ring
To remove movement between table top and pole
Brass - 4PR.48
Stainless Steel - 4PRSS.48



Parasol Base Required
Standard - 4PBM
Free Standing - 4PBFP + 4PBFTM

verona
4VE30R

With chrome fittings.
Suitable for the following tables:

- Arundel 2AR13
- 2AR18
- Aura 2AU15
- 2AU20
- Equinox 2EQ15
- 2EQ20.700
- Meizo 2ME15T
- Monaco 2MO15
- Stirling 2ST20
- Windsor 2WI15

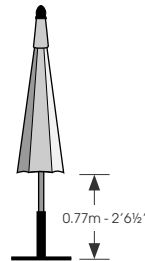
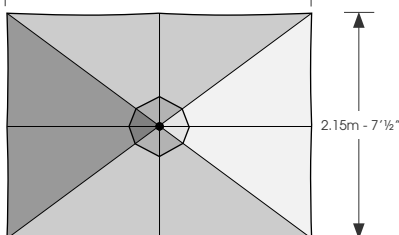
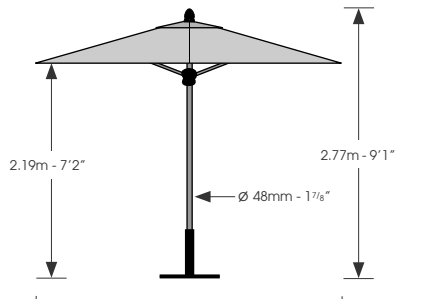

Optional Extras



Parasol Pole Reducer Ring
To remove movement between table top and pole
Brass - 4PR.48
Stainless Steel - 4PRSS.48



Parasol Base Required
Standard - 4PBM
Free Standing - 4PBFP + 4PBFTM

parasols

milano 4MI35C

With brass fittings. Suitable for the following tables:

Drummond
2DR15
2DR18
Horizon
2HOC15
2HOC18

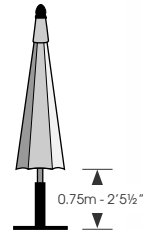
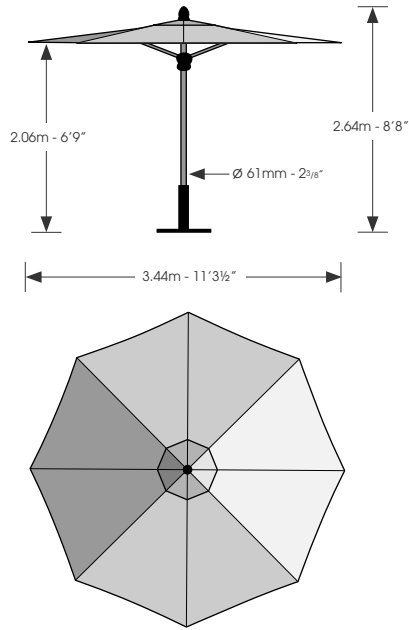

Optional Extras



Parasol Pole Reducer Ring
To remove movement between table top and pole
Brass - 4PR.61
Stainless Steel - 4PRSS.61



Parasol Base Required
Standard - 4PBL
Free Standing - 4PBFP + 4PBFTL

milano 4MI40C

With brass fittings. Suitable for the following tables:

Drummond
2DR18
Horizon
2HOC18

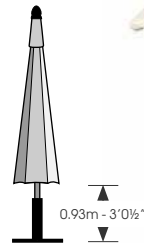
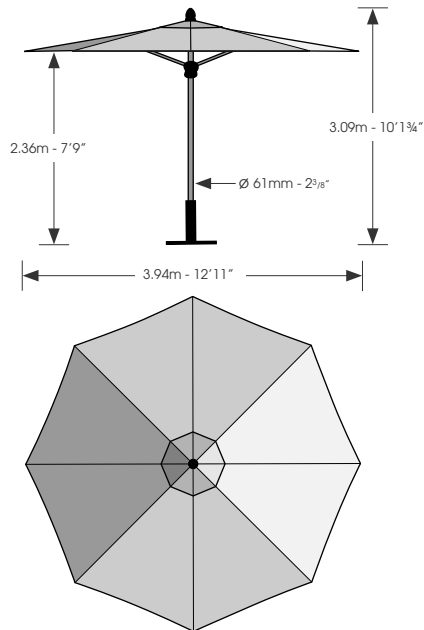

Optional Extras



Parasol Pole Reducer Ring
To remove movement between table top and pole
Brass - 4PR.61
Stainless Steel - 4PRSS.61



Parasol Base Required
Standard - 4PBL
Free Standing - 4PBFP + 4PBFTL

milano 4MI35R

With brass fittings. Suitable for the following tables:

Apex
2AP21
Arundel
2AR24
2ARX28
Eclipse
2EC20
Equinox
2EQ22
2EQX23
Stirling
2STX32
Windsor
2WIX23

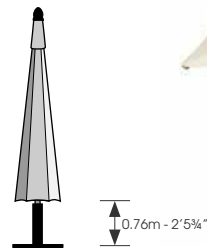
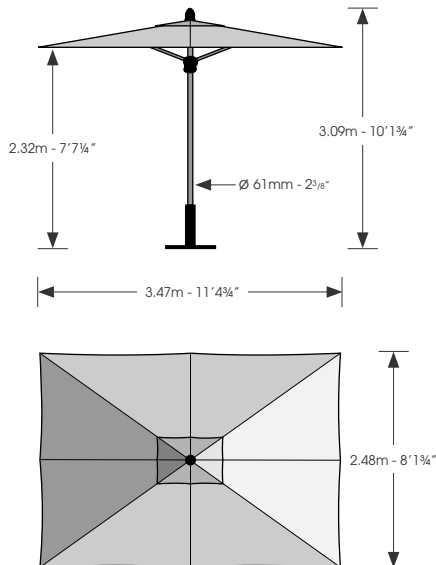

Optional Extras



Parasol Pole Reducer Ring
To remove movement between table top and pole
Brass - 4PR.61
Stainless Steel - 4PRSS.61



Parasol Base Required
Standard - 4PBL
Free Standing - 4PBFP + 4PBFTL

parasols

sorrento

4SO35C

With chrome fittings.
Suitable for the following tables:

Drummond
2DR15
2DR18
Equinox
2EQC15.700
2EQC18.700

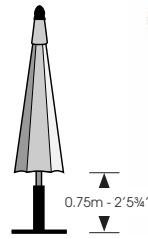
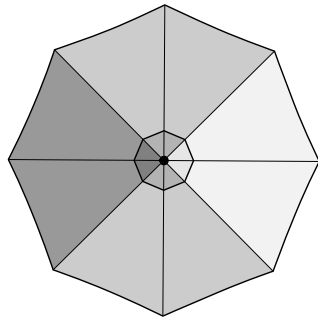
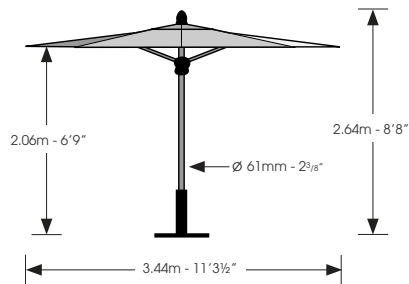

Optional Extras



Parasol Pole Reducer Ring
To remove movement between table top and pole
Brass - 4PR.61
Stainless Steel - 4PRSS.61



Parasol Base Required
Standard - 4PBL
Free Standing - 4PBFP + 4PBFTL

sorrento

4SO40C

With chrome fittings.
Suitable for the following tables:

Drummond
2DR18
Equinox
2EQC18S
2EQC18.700

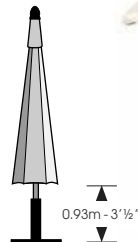
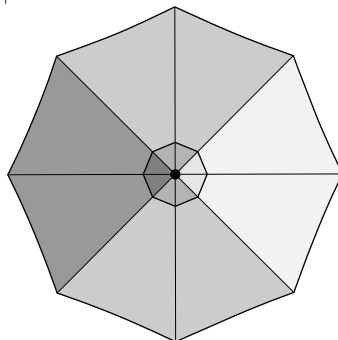
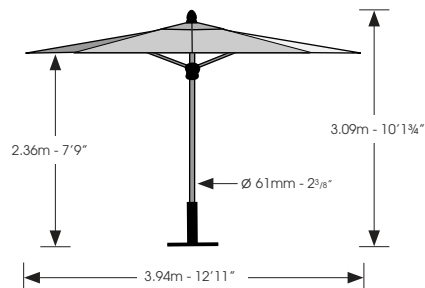

Optional Extras



Parasol Pole Reducer Ring
To remove movement between table top and pole
Brass - 4PR.61
Stainless Steel - 4PRSS.61



Parasol Base Required
Standard - 4PBL
Free Standing - 4PBFP + 4PBFTL

sorrento

4SO35R

With chrome fittings.
Suitable for the following tables:

Apex
2AP21
Arundel
2AR24
2ARX28
Eclipse
2EC20
Equinox
2EQ22
2EQX23
Stirling
2STX32
Windsor
2WIX23

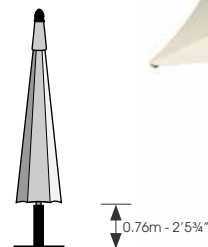
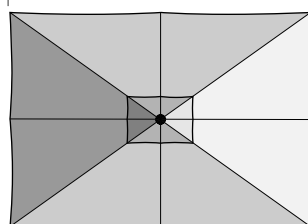
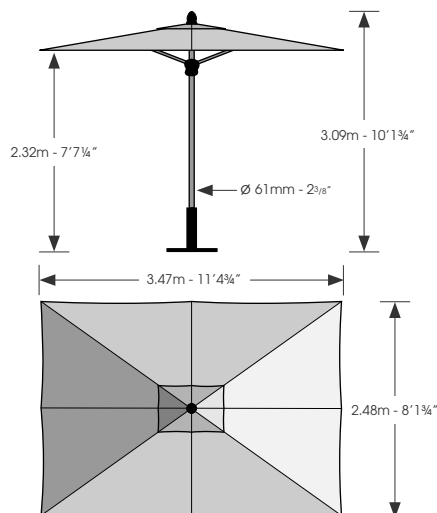

Optional Extras



Parasol Pole Reducer Ring
To remove movement between table top and pole
Brass - 4PR.61
Stainless Steel - 4PRSS.61



Parasol Base Required
Standard - 4PBL
Free Standing - 4PBFP + 4PBFTL

parasol bases

Standard parasol bases



4PBS
 ⌀ 40cm - 153/4"
 ↓ 41.5cm - 161/4"
 ⚖ 11.5kg - 25lbs



4PBM
 ⌀ 60cm - 231/2"
 ↓ 44cm - 171/4"
 ⚖ 25.5kg - 56lbs



4PBL
 ⌀ 60cm - 231/2"
 ↓ 44cm - 171/4"
 ⚖ 26kg - 57lbs

Free standing parasol bases



4PBFP + 4PBFTS
 ■ 74cm - 291/4"
 ■ 74cm - 291/4"
 ↓ 41.5cm - 161/4"
 ⚖ 45kg - 99lbs



4PBFP + 4PBFTM
 ■ 74cm - 291/4"
 ■ 74cm - 291/4"
 ↓ 44cm - 171/4"
 ⚖ 46kg - 101lbs



4PBFP + 4PBFTL
 ■ 74cm - 291/4"
 ■ 74cm - 291/4"
 ↓ 44cm - 171/4"
 ⚖ 46.5kg - 102lbs

Parasol Base Plates

For 2EQC07, 2EQCH07, 2EQC10, 2EQCH10



4PBPS
 ⌀ 40cm - 153/4"
 ⚖ 10.5kg - 23lbs
 2EQC07
 2EQCH07



4PBPL
 ⌀ 60cm - 231/2"
 ⚖ 22kg - 48lbs
 2EQC10
 2EQCH10



reducer rings

storage covers

Parasol Hole Reducer Rings

Brass



4PR.00
 ⌀ 79mm - 31/4"



4PR.38
 ⌀ 38mm - 11/2"



4PR.48
 ⌀ 48mm - 17/8"



4PR.61
 ⌀ 61mm - 23/8"

Parasol Hole Reducer Rings

Stainless Steel



4PRSS.00
 ⌀ 79mm - 31/4"



4PRSS.38
 ⌀ 38mm - 11/2"



4PRSS.48
 ⌀ 48mm - 17/8"



4PRSS.61
 ⌀ 61mm - 23/8"

Parasol Storage Covers



4PSCS
 Siena - 4SI25C

4PSCL
 Verona - 4VE30C, 4VE30R
 Milano - 4MI35C, 4MI35R, 4MI40C
 Sorrento - 4SO35C, 4SO35R, 4SO40C

specifications

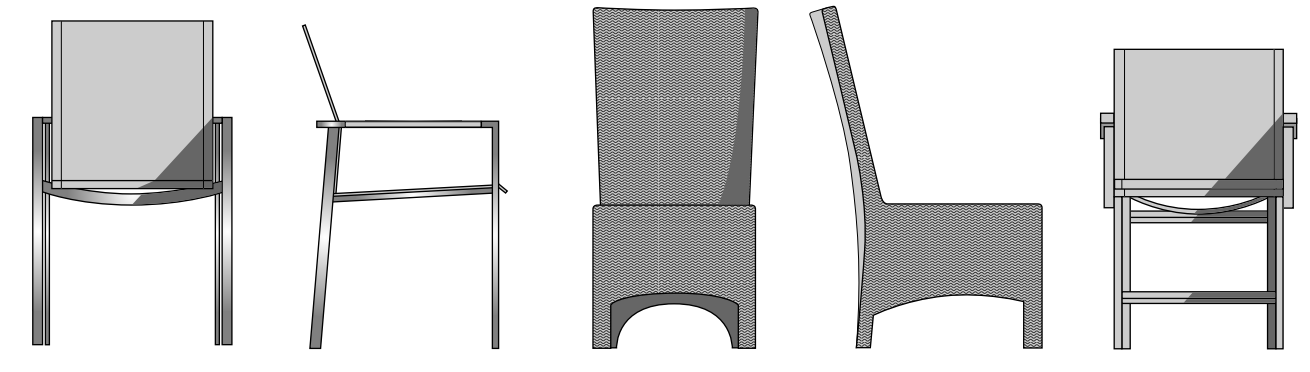

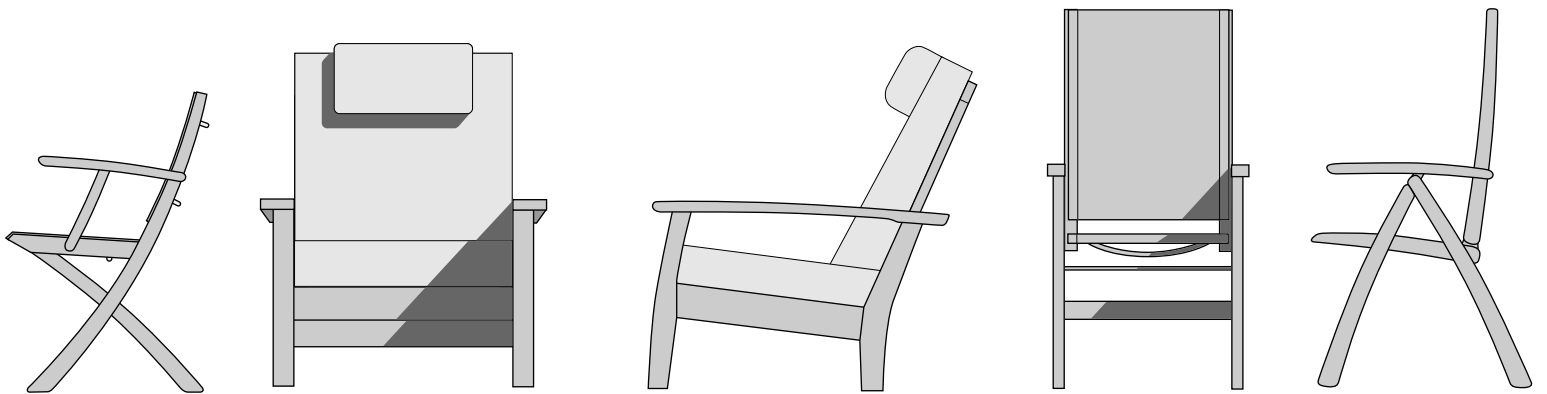

In the following section, we show all our products with a full specification.

Product dimensions and weights are approximate.

Whilst we take care to reproduce colours as accurately as possible, you should only use them as a guide, due to the limitations of the printing process.

Cushions we supply in North America might be different in style and colour from those illustrated.

teak

adirondack



Armchair
1ADA (p. 8)

- 75.5cm - 29 3/4"
- 95.5cm - 37 1/2"
- 96.5cm - 38"
- 17kg - 37lbs



Footrest
1ADFR (p. 8)

- 54cm - 21 1/4"
- 35.5cm - 14"
- 57cm - 22 1/2"
- 6kg - 13lbs



Side Table
2AD (p. 8)

- 62cm - 24 1/2"
- 39cm - 15 1/4"
- 39.5cm - 15 1/2"
- 5.5kg - 12lbs

apex



Armchair
1APA (p. 10)

- 59.5cm - 23 1/2"
- 91cm - 35 3/4"
- 61cm - 24"
- 14kg - 31lbs
- 800087



210 Dining Table
2AP21 (p. 11)

- 210cm - 82 3/4"
- 74.5cm - 29 1/4"
- 109cm - 42 3/4"
- 81kg - 178lbs
- 6 - 8
- 4MI35R, 4SO35R



Without parasol hole

390 Extending Dining Table
2APX39 (p. 10)

- 268.5 / 392cm
105 3/4" / 154 1/4"
- 74.5cm - 29 1/4"
- 119cm - 46 3/4"
- 125kg - 275lbs
- 14

ascot



Folding Side Chair
1AS (p. 12)

- 48cm - 19"
- 95cm - 37 1/2"
- 61.5cm - 24 1/4"
- 7kg - 15lbs
- 800004



Folding Carver Chair
1ASC (p. 12)

- 58cm - 22 3/4"
- 95cm - 37 1/2"
- 61.5cm - 24 1/4"
- 8kg - 17lbs
- 800004



Folding Footstool / Side Table
1ASF5 (p. 12)

- 43.5cm - 17 1/4"
- 40.5cm - 16"
- 43.5cm - 17 1/4"
- 4.5kg - 10lbs
- 800004



Folding Recliner Chair
1ASR (p. 14)

- 59.5cm - 23 1/2"
- 113.5cm - 44 3/4"
- 64cm - 25 1/4"
- 13kg - 28lbs
- 800002, 800003



Folding Recliner Footstool / Side Table
1REF5

- 41.5cm - 16 1/4"
- 41.5cm - 16 1/4"
- 43.5cm - 17"
- 5kg - 11lbs
- 800041



Recliner Clip-on Tray
1RET

- 32cm - 12 1/2"
- 20.5cm - 8"
- 1.3kg - 3lbs
- For 1ASR

teak

ascot



110 Folding Dining Table
2AS11 (p. 12)

- ∅ 109cm - 43"
- ┆ 70cm - 273/4"
- ⚖ 14kg - 31lbs
- 👤 4
- ⤴ 4SI25C



130 Folding Dining Table
2AS13

- ∅ 130cm - 511/4"
- ┆ 70cm - 273/4"
- ⚖ 22.5kg - 50lbs
- 👤 4 - 6
- ⤴ 4VE30C

capri



Lounger - Base
1CAB

- ↔ 198cm - 78"
- ↔ 24cm - 91/2"
- ≡ 63cm - 243/4"
- ⚖ 21kg - 46lbs
- ⤴ 800006



Brass Clips
1CBC

- ▤ 6.7cm - 25/8"
- ▤ 7.8cm - 31/8"
- ┆ 1.9cm - 3/4"
- ⚖ 300g - 11oz

For connecting two or more Capri Base Loungers



Lounger - Standard
1CAS (p. 17)

- ↔ 197cm - 771/2"
- ↔ 31cm - 121/4"
- ≡ 70cm - 273/4"
- ⚖ 19.5kg - 43lbs
- ⤴ 800006



Clip-on Tray
1CAT

- ≡ 39.5cm - 151/2"
- ≡ 23cm - 9"
- ⚖ 1.3kg - 3lbs
- For 1CAS



Lounger - Ultra
1CAU (p. 16)

- ↔ 197cm - 771/2"
- ↔ 31cm - 121/4"
- ≡ 74cm - 291/4"
- ⚖ 29kg - 64lbs
- ⤴ 800006 (810510 in USA only)

commodore



Folding Steamer Chair
1CO (p. 18)

- ▤ 63.5cm - 25"
- ┆ 99.5cm - 391/4"
- ┆ 146cm - 571/2"
- ⚖ 18.5kg - 41lbs
- ⤴ 800066



*Folding Steamer Chair
Wheels and 67cm Footrest*
1CO67W





- ▤ 63.5cm - 25"
- ┆ 102cm - 40"
- ┆ 163cm - 64"
- ⚖ 20.5kg - 45lbs
- ⤴ 800067

teak

commodore





Folding Recliner Chair
1COC

-  63.5cm - 25"
-  112.5cm - 44 1/4"
-  82cm - 32 1/4"
-  15kg - 33lbs
-  800002, 800003

felsted







Armchair
1FEA (p. 20)

-  55.5cm - 21 3/4"
-  86.5cm - 34 1/4"
-  61.5cm - 24 1/4"
-  12kg - 26lbs
-  800001



Footstool / Side Table
1FEFS (p. 24)

-  42cm - 16 1/2"
-  42cm - 16 1/2"
-  42cm - 16 1/2"
-  6kg - 13lbs
-  800041



120 Seat
1FE12

-  116cm - 45 3/4"
-  86.5cm - 34 1/4"
-  61.5cm - 24 1/4"
-  17kg - 37lbs
-  800012



150 Seat
1FE15

-  147cm - 57 3/4"
-  86.5cm - 34 1/4"
-  61.5cm - 24 1/4"
-  19kg - 42lbs
-  800015



A Felsted 180cm Seat, 1FE18KD, is available in the USA only. Please refer to our website www.teak.com for details

haven

For cushion colours see page 174







Reclining Armchair
1HADA (p. 22)

-  84.5cm - 33 1/4"
-  101cm - 39 3/4"
-  97cm - 38 1/4"
-  18kg - 40lbs

Note: Headrest not available in USA



Ottoman
1HAO (p. 22)

-  79cm - 31"
-  39.5cm - 15 1/2"
-  65cm - 25 1/2"
-  9kg - 20lbs



Left Hand Module
1HADML (p. 23)

-  75cm - 29 1/2"
-  92.5cm - 36 1/2"
-  93cm - 36 1/2"
-  14.5kg - 32lbs



Right Hand Module
1HADMR (p. 23)

-  75cm - 29 1/2"
-  92.5cm - 36 1/2"
-  93cm - 36 1/2"
-  14.5kg - 32lbs

For cushion colours see page 174



Middle Module
1HADMM (p. 23)

▣ 65cm - 25 1/2"
┌┐ 92.5cm - 36 1/2"
┌┐ 90.5cm - 35 1/2"
⚖ 11kg - 24lbs



Corner Module
1HADMC (p. 23)

▣ 90.5cm - 35 1/2"
┌┐ 92.5cm - 36 1/2"
┌┐ 90.5cm - 35 1/2"
⚖ 16kg - 35lbs



100 Conversation Table
2HASC10

▣ 100cm - 39 1/4"
┌┐ 48cm - 18 3/4"
▣ 100cm - 39 1/4"
⚖ 17.5kg - 39lbs
⚙ 4VE30C



100 Conversation Table
2HACC10

⊘ 102cm - 40"
┌┐ 48cm - 18 3/4"
⚖ 18kg - 40lbs
⚙ 4VE30C



Armchair
1GLA (p. 24)

▣ 57.5cm - 22 3/4"
┌┐ 90cm - 35 1/2"
┌┐ 64.5cm - 25 1/4"
⚖ 16kg - 35lbs
⚙ 800001



150 Seat
1GL15 (p. 27)

▣ 149cm - 58 3/4"
┌┐ 90cm - 35 1/2"
┌┐ 64.5cm - 25 1/4"
⚖ 26kg - 57lbs
⚙ 800015



180 Seat
1GL18

▣ 179.5cm - 70 3/4"
┌┐ 90cm - 35 1/2"
┌┐ 64.5cm - 25 1/4"
⚖ 33kg - 73lbs
⚙ 800018



240 Seat
1GL24

▣ 236.5cm - 93"
┌┐ 90cm - 35 1/2"
┌┐ 64.5cm - 25 1/4"
⚖ 43kg - 95lbs



Junior Armchair
1GLJA (p. 26)

▣ 41.5cm - 16 1/2"
┌┐ 65.5cm - 25 3/4"
┌┐ 46cm - 18"
⚖ 7kg - 15lbs



Junior Seat
1GLJ2 (p. 26)

▣ 75.5cm - 29 3/4"
┌┐ 65.5cm - 25 3/4"
┌┐ 46cm - 18"
⚖ 9.5kg - 21lbs



Cambridge Junior Table
2CAJ (p. 26)

▣ 76cm - 30"
┌┐ 48cm - 18 3/4"
▣ 49cm - 19 1/4"
⚖ 8kg - 17lbs

Two half sections are required to make a complete tree seat.
Can be supplied as a single half section if required.



Hexagonal Tree seat
1GLHE

- ∅ 223.5cm - 88"
- H 90cm - 35 1/2"
- ⚖ 45kg - 99lbs

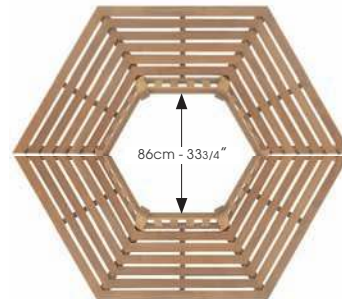

1GLHE + 1GLHE

Two half sections are required to make a complete tree seat.
Can be supplied as a single half section if required.



Circular Tree seat
1GLSC (p. 28)

- ∅ 219.5cm - 86 1/2"
- H 90cm - 35 1/2"
- ⚖ 46kg - 101lbs

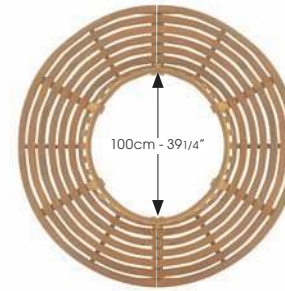

1GLSC + 1GLSC



Curved Seat
1GLR28

- ∅ 223.5cm - 88"
- H 90cm - 35 1/2"
- H 64.5cm - 25 1/4"
- ⚖ 36kg - 79lbs



Curved Seat - Left
1GLR28L

- ∅ 221cm - 87"
- H 90cm - 35 1/2"
- H 64.5cm - 25 1/4"
- ⚖ 33kg - 73lbs



Curved Seat - Centre
1GLR28C

- ∅ 218cm - 85 3/4"
- H 90cm - 35 1/2"
- H 60cm - 23 1/2"
- ⚖ 30kg - 66lbs



Curved Seat - Right
1GLR28R

- ∅ 221cm - 87"
- H 90cm - 35 1/2"
- H 64.5cm - 25 1/4"
- ⚖ 33kg - 73lbs

The Glenham Curved Seat is also available to special order, as left and right hand sections, plus a centre section. By combining these sections, larger circular seating arrangements are possible.



1GLR28L + 1GLR28R



1GLR28L + 1GLR28C + 1GLR28R

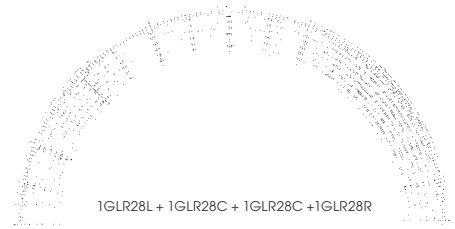

1GLR28L + 1GLR28C + 1GLR28C + 1GLR28R

Two sections are required for complete corner seat. Also available to special order with the 'London' style armrests, which increases the overall lengths by 5cm - 2".



Corner Seat - Left
1GL18CL

185.5cm - 73"
90cm - 35 1/2"
64.5cm - 25 1/4"
29kg - 64lbs



Corner Seat - Right
1GL18CR

185.5cm - 73"
90cm - 35 1/2"
64.5cm - 25 1/4"
29kg - 64lbs

horizon



Stacking Armchair
1HOAS.T (p. 32)

58cm - 23"
90cm - 35 1/4"
56.5cm - 22 1/4"
7.5kg - 17lbs
800008



Stacking Armchair (p. 34)

1HOAS.500 Charcoal
1HOAS.501 White
1HOAS.502 Titanium
1HOAS.503 Aquamarine
1HOAS.504 Platinum

58cm - 23"
90cm - 35 1/4"
58.5cm - 23"
6.5kg - 14lbs

For sling colours see page 176

For sling colours see page 176



Lounger (p. 38)

1HOL.500 Charcoal
1HOL.501 White
1HOL.502 Titanium
1HOL.503 Aquamarine
1HOL.504 Platinum

206.5cm - 81 1/4"
32cm - 12 3/4"
65.5cm - 25 3/4"
16.5kg - 36lbs



Lounger Sun Shade (p. 38)

1LSS.500 Charcoal
1LSS.501 White
1LSS.502 Titanium
1LSS.503 Aquamarine
1LSS.504 Platinum

62cm - 24 1/2"
35cm - 13 3/4"
1kg - 2.4lbs



Folding Side Chair

1HOF.500 Charcoal
1HOF.501 White
1HOF.502 Titanium
1HOF.503 Aquamarine
1HOF.504 Platinum

48cm - 18 3/4"
83.5cm - 32 3/4"
57cm - 22 1/2"
6.5kg - 14lbs



Folding Carver Chair (p. 30)

1HOCF.500 Charcoal
1HOCF.501 White
1HOCF.502 Titanium
1HOCF.503 Aquamarine
1HOCF.504 Platinum

55cm - 21 3/4"
83.5cm - 32 3/4"
57cm - 22 1/2"
7kg - 15lbs



Folding Recliner Chair (p. 36)

1HOR.500 Charcoal
1HOR.501 White
1HOR.502 Titanium
1HOR.503 Aquamarine
1HOR.504 Platinum

59.5cm - 23 1/4"
111.5cm - 43 3/4"
65.5cm - 25 3/4"
12kg - 26lbs

teak

horizon



150 Dining Table
2HOC15

- ∅ 149.5cm - 59"
- ┆┆ 70cm - 273/4"
- ⚖ 41kg - 90lbs
- 👤 6
- ⤴ 4VE30C



180 Dining Table (p. 41)
2HOC18

- ∅ 179.5cm - 703/4"
- ┆┆ 70cm - 273/4"
- ⚖ 70kg - 154lbs
- 👤 6
- ⤴ 4MI40C, 4SO40C

linear



Armchair
1LIA (p. 40)

- ┆ 58cm - 23"
- ┆┆ 90.5cm - 353/4"
- ┆┆ 61cm - 241/4"
- ⚖ 9kg - 20lbs
- 👉 800087

london



Armchair
1LOA (p. 43)

- ┆ 69.5cm - 271/4"
- ┆┆ 90cm - 351/2"
- ┆┆ 63.5cm - 25"
- ⚖ 17kg - 37lbs
- 👉 800001



150 Seat
1LO15 (p. 42)

- ┆ 161cm - 631/4"
- ┆┆ 90cm - 351/2"
- ┆┆ 63.5cm - 25"
- ⚖ 26kg - 57lbs
- 👉 800015



180 Seat
1LO18

- ┆ 191cm - 751/4"
- ┆┆ 90cm - 351/2"
- ┆┆ 63.5cm - 25"
- ⚖ 32kg - 70lbs
- 👉 800018

For cushion colours see page 174



Reclining Armchair
1MIA (p. 51)

- 74cm - 29"
- 94.5cm - 37 1/4"
- 98.5cm - 38 3/4"
- 28.5kg - 63lbs



Footstool
1MIFS

- 45.5cm - 18"
- 35.5cm - 14"
- 45.5cm - 18"
- 6.2kg - 13.5lbs



60 Coffee Table
2MIL06

- 59cm - 23 1/4"
- 39.5cm - 15 1/2"
- 59cm - 23 1/4"
- 10kg - 22lbs



Folding Side Chair
1MOF (p. 46)

- 48cm - 18 3/4"
- 87.5cm - 34 1/2"
- 57cm - 22 1/2"
- 6.5kg - 14lbs
- 800004



Folding Carver Chair
1MOCF (p. 46)

- 55cm - 21 3/4"
- 87.5cm - 34 1/2"
- 57cm - 22 1/2"
- 7kg - 15lbs
- 800004



Side Chair
1MO (p. 45)

- 48cm - 18 3/4"
- 92.5cm - 36 1/2"
- 63cm - 24 3/4"
- 10kg - 22lbs
- 800005



Armchair
1MOA (p. 44)

- 56.5cm - 22 1/4"
- 92.5cm - 36 1/2"
- 63cm - 24 3/4"
- 10kg - 22lbs
- 800001



120 Seat
1MO12

- 121cm - 47 1/2"
- 92.5cm - 36 1/2"
- 64cm - 25 1/4"
- 17kg - 37lbs
- 800012



150 Seat
1MO15 (p. 45)

- 146cm - 57 1/2"
- 92.5cm - 36 1/2"
- 64cm - 25 1/4"
- 20kg - 44lbs
- 800015



150 Swing Seat
1MOSW15

- 149.5cm - 58 3/4"
- 65cm - 25 1/2"
- 61cm - 24"
- 21.5kg - 47lbs
- 800015



High Dining Side Chair
1MOH

- 48cm - 18 3/4"
- 121cm - 47 1/2"
- 60cm - 23 3/4"
- 12kg - 26lbs
- 800005



High Dining Carver Chair
1MOCH

- 57cm - 22 1/2"
- 121cm - 47 1/2"
- 60cm - 23 3/4"
- 13kg - 28lbs
- 800005

teak

monaco



Lounger
1MOL (p. 50)

- 205cm - 803/4"
- 29cm - 111/2"
- 78cm - 303/4"
- 30kg - 66lbs
- 800006

40 Coffee Table
2MOL04



- 43.5cm - 171/4"
- 40cm - 153/4"
- 43.5cm - 171/4"
- 5kg - 11lbs

60 Coffee Table
2MOL06



- 59cm - 231/4"
- 40cm - 153/4"
- 59cm - 231/4"
- 9kg - 20lbs

100 Coffee Table
2MOL10



- 101cm - 393/4"
- 40cm - 153/4"
- 59cm - 231/4"
- 12kg - 26lbs

150 Coffee Table
2MOL15



- 150cm - 59"
- 39.5cm - 151/2"
- 90.5cm - 351/2"
- 21.5kg - 47lbs

150 Dining Table
2MO15 (p. 48)



- 150cm - 59"
- 71cm - 273/4"
- 90.5cm - 351/2"
- 23kg - 51lbs
- 4 - 6
- 4VE30R

240 Extending
Dining Table
2MOX24



- 175cm / 240cm
69" / 941/2"
- 71cm - 273/4"
- 90.5cm - 351/2"
- 36kg - 79lbs
- 8 - 10
- 4MI35R, 4SO35R

newport



Rocking Chair
1NER (p. 61)

- 64cm - 251/4"
- 105cm - 411/4"
- 88.5cm - 343/4"
- 13kg - 28lbs
- 800002, 800003

teak

provence



Side Chair
1PR

48cm - 19"
83.5cm - 32³/₄"
55.5cm - 22"
7kg - 15lbs
800005



Armchair
1PRA

52.5cm - 20³/₄"
83.5cm - 32³/₄"
56.5cm - 22¹/₄"
8.5kg - 19lbs
800001

rothesay



Armchair
1ROA (p. 52)

69.5cm - 27¹/₂"
90.5cm - 35¹/₂"
65.5cm - 25³/₄"
24kg - 53lbs



180 Seat
1RO18 (p. 53)

182cm - 71³/₄"
90.5cm - 35¹/₂"
65.5cm - 25³/₄"
37kg - 81lbs



240 Seat
1RO24

240.5cm - 94¹/₂"
90.5cm - 35¹/₂"
65.5cm - 25³/₄"
51kg - 112lbs

safari



Folding Armchair
1SA.200 Forest Green
1SA.201 White Sand
1SA.204 Pepper
1SA.205 Classic Blue
1SA.207 Spring

60cm - 23¹/₂"
81cm - 32"
50cm - 19¹/₂"
5.5kg - 12lbs



.200 Forest Green



.201 White Sand



.204 Pepper



.205 Classic Blue



.207 Spring (Not available in the USA)



Safari Clip-on Tray
1SAT (p. 54)

31cm - 12¹/₄"
17cm - 6¹/₂"
1.3kg - 3lbs



Folding Table
2SA (p. 52)

68cm - 26³/₄"
70cm - 27³/₄"
58cm - 22³/₄"
8kg - 17lbs
2

sissinghurst



195 Seat
1SI (p. 56)

195.5cm - 77"
106cm - 41³/₄"
64.5cm - 25¹/₂"
38kg - 84lbs

teak

waveney



Armchair
1WAA (p. 59)

- 55.5cm - 213/4"
- 85.5cm - 333/4"
- 58.5cm - 23"
- 10.5kg - 23lbs
- 800001



120 Seat
1WA12

- 116cm - 453/4"
- 87.5cm - 341/2"
- 58.5cm - 23"
- 15kg - 33lbs
- 800012



150 Seat
1WA15 (p. 58)

- 147cm - 573/4"
- 89cm - 35"
- 58.5cm - 23"
- 18.5kg - 41lbs
- 800015

wimbledon



120 Bench
1WI12 (p. 61)

- 121cm - 473/4"
- 41.5cm - 161/2"
- 53cm - 203/4"
- 13kg - 28lbs
- 800068



150 Bench
1WI15 (p. 61)

- 149cm - 583/4"
- 41.5cm - 161/2"
- 53cm - 203/4"
- 16kg - 35lbs
- 800069



180 Bench
1WI18 (p. 61)

- 179.5cm - 703/4"
- 42.5cm - 163/4"
- 53cm - 203/4"
- 20kg - 44lbs
- 800071

arundel



90 Dining Table
2AR09

- 90cm - 351/2"
- 70cm - 273/4"
- 90cm - 351/2"
- 24kg - 53lbs
- 4
- 4SI25C



180 Dining Table
2AR18 (p. 12)

- 180cm - 703/4"
- 70cm - 273/4"
- 90cm - 351/2"
- 42kg - 92lbs
- 6 - 8
- 4VE30R



240 Dining Table
2AR24 (p. 24)

- 240cm - 941/2"
- 70cm - 273/4"
- 108.5cm - 423/4"
- 51.5kg - 113lbs
- 8 - 10
- 4MI35R, 4SO35R

Without parasol hole when closed



285 Extending Dining Table
2ARX28 (p. 14)

- 204.5 / 286.5cm
801/2" / 1123/4"
- 70cm - 273/4"
- 110cm - 431/4"
- 75kg - 165lbs
- 10 - 12
- 4MI35R, 4SO35R

teak

balmoral



110 Dining Table
2BA11

Ø 109cm - 43"
 T 70cm - 273/4"
 ⚖ 23kg - 51lbs
 👤 4
 ⚙ 4SI25C



130 Dining Table
2BA13 (p. 20)

Ø 130cm - 51 1/4"
 T 70cm - 273/4"
 ⚖ 31kg - 68lbs
 👤 4 - 6
 ⚙ 4VE30C

drummond



150 Dining Table
2DR15

Ø 150cm - 59"
 T 70cm - 273/4"
 ⚖ 46kg - 101lbs
 👤 6
 ⚙ 4VE30C



75 Lazy Susan
2LS07

Ø 74cm - 29 1/4"
 ⚖ 7kg - 15lbs



180 Dining Table
2DR18 (back cover)

Ø 185cm - 72 3/4"
 T 70cm - 273/4"
 ⚖ 65kg - 143lbs
 👤 8
 ⚙ 4MI40C, 4SO40C



110 Lazy Susan
2LS11 (back cover)

Ø 109cm - 43"
 ⚖ 14kg - 31lbs

edinburgh



90 Coffee Table
2EDL09

Ø 90cm - 35 1/2"
 T 42.5cm - 163/4"
 ⚖ 16kg - 35lbs



90 Dining Table
2ED09 (p. 59)

Ø 90cm - 35 1/2"
 T 70cm - 273/4"
 ⚖ 19kg - 42lbs
 👤 2 - 4
 ⚙ 4SI25C



90 High Dining Table
2EDH09

Ø 90cm - 35 1/2"
 T 98.5cm - 38 3/4"
 ⚖ 22kg - 49lbs
 👤 2 - 4
 ⚙ 4SI25C

metzo



90 Dining Table
2ME09T (p. 120)

▮ 89.5cm - 35 1/4"
 T 74.5cm - 29 1/4"
 ▮ 89.5cm - 35 1/4"
 ⚖ 29kg - 64lbs
 👤 4
 ⚙ 4SI25C



150 Dining Table
2ME15T

▮ 149.5cm - 59"
 T 74.5cm - 29 1/4"
 ▮ 89.5cm - 35 1/4"
 ⚖ 37kg - 97lbs
 👤 6
 ⚙ 4VE30R

teak

stirling



200 Dining Table
2ST20

- 200cm - 783/4"
- 70cm - 273/4"
- 108.5cm - 423/4"
- 46kg - 101lbs
- 6 - 8
- 4VE30R



320 Extending Dining Table
2STX32

- 237cm / 319cm
931/4" / 1251/2"
- 70cm - 273/4"
- 110cm - 431/4"
- 78kg - 172lbs
- 10 - 12
- 4MI35R, 4SO35R

windsor



82 Dining Table
2WI08

- 82.5cm - 321/2"
- 70cm - 273/4"
- 82.5cm - 321/2"
- 16kg - 35lbs
- 2 - 4
- 4SI25C



120 Dining Table
2WI12

- 119.5cm - 47"
- 70cm - 273/4"
- 82.5cm - 321/2"
- 21kg - 46lbs
- 4 - 6
- 4VE30R



150 Dining Table
2WI15

- 150cm - 59"
- 70cm - 273/4"
- 82.5cm - 321/2"
- 23kg - 51lbs
- 6 - 8
- 4VE30R



235 Extending Dining Table
2WIX23 (p. 45)

- 170cm / 235cm
67" / 921/2"
- 71cm - 273/4"
- 103cm - 403/4"
- 50kg - 110lbs
- 6 - 8
- 4MI35R, 4SO35R



150 Dining Table
2WIC15 (p. 46)

- Ø 150cm - 59"
- 70cm - 273/4"
- 30kg - 66lbs
- 6
- 4VE30C



75 Lazy Susan
2LS07 (p. 46)

- Ø 74cm - 291/4"
- 7kg - 15lbs

cambridge

accessories



76 Coffee Table
2CA

- 76cm - 30"
- 36.5cm - 141/4"
- 49cm - 191/4"
- 7.5kg - 17lbs

teak

colchester



54 Coffee Table
2COL (p. 25)

- 54.5cm - 21 1/2"
- 40cm - 15 3/4"
- 54.5cm - 21 1/2"
- 8kg - 17lbs

54 Side Table
2COH

- 54.5cm - 21 1/2"
- 54cm - 21 1/4"
- 54.5cm - 21 1/2"
- 9kg - 20lbs

crichton



Serving Trolley
2CR (p. 60)

- 124.5cm - 49"
- 85cm - 33 1/2"
- 62.5cm - 24 1/2"
- 37kg - 81lbs



Serving Tray
3ST (p. 60)

- 53.5cm - 21"
- 36cm - 14 1/4"
- 2.5kg - 5lbs

caisse versailles



45 Caisse Versailles
3CV45 (p. 61)

- 45.5cm - 18"
- 51cm - 20 1/4"
- 45.5cm - 18"
- 12kg - 26lbs



60 Caisse Versailles
3CV60

- 60.5cm - 23 3/4"
- 66.5cm - 26 1/4"
- 60.5cm - 23 3/4"
- 21kg - 46lbs

reims



Refreshments Chest
3RE (p. 60)

- 81cm - 31 3/4"
- 60cm - 23 1/2"
- 57.5cm - 22 3/4"
- 35kg - 77lbs

The Reims Refreshments chest has an inner liner of polypropylene and can easily accommodate twelve bottles of Champagne or any other refreshments needing to be kept cool. Melted ice can be drained using the solid brass tap at the back of the chest.

storage chests



Storage Chest
3SC11

- 114cm - 45"
- 72.5cm - 28 1/2"
- 63cm - 24 3/4"
- 50kg - 110lbs



Storage Chest
3SC15 (p. 60)

- 157.5cm - 62"
- 72.5cm - 28 1/2"
- 84.5cm - 33 1/4"
- 70kg - 154lbs

stainless steel

equinox

316 grade stainless steel

For sling and armrest colours see page 177



Stacking Side Chair

1EQ.500 Charcoal
1EQ.501 White
1EQ.502 Titanium
1EQ.503 Aquamarine
1EQ.504 Platinum

51cm - 20"
85cm - 33 1/2"
61cm - 24"
8kg - 17lbs



Stacking Armchair (p. 66)

	Armrest	Sling
1EQA.01.500	Graphite	- Charcoal
1EQA.01.502	Graphite	- Titanium
1EQA.01.504	Graphite	- Platinum
1EQA.02.501	Arctic White	- White
1EQA.02.503	Arctic White	- Aquamarine
1EQA.500	Teak	- Charcoal
1EQA.501	Teak	- White
1EQA.502	Teak	- Titanium
1EQA.503	Teak	- Aquamarine
1EQA.504	Teak	- Platinum

60cm - 23 1/2"
85cm - 33 1/2"
61.5cm - 24 1/4"
9kg - 20lbs

Stacking Lounger (p. 74)

	Armrest	Sling
1EQL.01.500	Graphite	- Charcoal
1EQL.01.502	Graphite	- Titanium
1EQL.01.504	Graphite	- Platinum
1EQL.02.501	Arctic White	- White
1EQL.02.503	Arctic White	- Aquamarine



196.5cm - 77 1/4"
31.5cm - 12 1/4"
68.5cm - 27"
23kg - 51lbs

	Armrest	Sling
1EQL.500	Teak	- Charcoal
1EQL.501	Teak	- White
1EQL.502	Teak	- Titanium
1EQL.503	Teak	- Aquamarine
1EQL.504	Teak	- Platinum

60cm - 23 1/2"
85cm - 33 1/2"
61.5cm - 24 1/4"
9kg - 20lbs

Lounger Sun Shade (p. 38)

1LSS.500 Charcoal
1LSS.501 White
1LSS.502 Titanium
1LSS.503 Aquamarine



62cm - 24 1/2"
35cm - 13 3/4"
1kg - 2.4lbs



Stacking Side Chair 1EQ.T (p. 64)

51cm - 20"
85cm - 33 1/2"
61cm - 24"
8kg - 18lbs
800005



Stacking Armchair 1EQA.T (p. 65)

60cm - 23 1/2"
85cm - 33 1/2"
61.5cm - 24 1/4"
9kg - 20lbs
800005



Side Chair 1EQH.T (p. 78)

47.5cm - 18 3/4"
106.5cm - 42"
50.5cm - 20"
8kg - 18lbs



Carver Chair 1EQHC.T (p. 79)

56.5cm - 22 1/4"
106.5cm - 42"
50.5cm - 20"
9.5kg - 21lbs



Stool 1EQHS.T (p. 78)

45.5cm - 16 1/4"
72cm - 28 1/4"
48cm - 18 3/4"
7.5kg - 17lbs



Backless Bench 1EQ13 (p. 67)

135.5cm - 53 1/4"
43cm - 17"
44cm - 17 1/4"
16kg - 35lbs

stainless steel

equinox

316 grade
stainless steel



Stacking Lounger
1EQLT (p. 75)

- 196.5cm - 77 1/4"
- 31.5cm - 12 1/4"
- 68.5cm - 27"
- 23kg - 51lbs
- 800006



Lounge Side Table
2EQLT (p. 77)

- 49cm - 19 1/4"
- 30cm - 11 3/4"
- 35cm - 13 3/4"
- 6.5kg - 14lbs



40 Coffee Table
2EQL04

- 43.5cm - 17 1/4"
- 40cm - 15 3/4"
- 43.5cm - 17 1/4"
- 9kg - 20lbs



60 Coffee Table
2EQL06 (p. 87)

- 59cm - 23 1/4"
- 40cm - 15 3/4"
- 59cm - 23 1/4"
- 11kg - 24lbs



100 Coffee Table
2EQL10

- 101cm - 39 3/4"
- 40cm - 15 3/4"
- 59cm - 23 1/4"
- 15kg - 33lbs



114 Serving Table
2EQS (p. 79)

- 114cm - 44 3/4"
- 85cm - 33 1/2"
- 59cm - 23 1/4"
- 29kg - 65lbs



100 Conversation Table
2EQSC10

- 97cm - 39 1/4"
- 48cm - 18 3/4"
- 100cm - 38 1/4"
- 22kg - 48lbs
- 4SI25C



100 Conversation Table
2EQCC10

- 102cm - 40"
- 48cm - 18 3/4"
- 20kg - 44lbs
- 4SI25C



100 Dining Table
2EQ10 (p. 66)

- 97cm - 38 1/4"
- 73cm - 28 3/4"
- 100cm - 39 1/4"
- 25kg - 55lbs
- 4
- 4SI25C



150 Dining Table
2EQ15 (p. 65)

- 149cm - 58 3/4"
- 73cm - 28 3/4"
- 100cm - 39 1/4"
- 30kg - 66lbs
- 6
- 4VE30R

stainless steel

equinox

316 grade
stainless steel



stainless steel

equinox

316 grade
stainless steel

For laminate top colour see page 178



90 Dining Table
2EQ09.700 Slate Grey (p. 73)

- 90cm - 35 1/2"
- 71cm - 28"
- 90cm - 35 1/2"
- 26.5kg - 58lbs
- 4
- 4VE30R, 4VE30C

Laminate Top



150 Dining Table
2EQ15.700 Slate Grey

- 145cm - 57"
- 71cm - 28"
- 90cm - 35 1/2"
- 32kg - 70lbs
- 6 - 8
- 4VE30R

Laminate Top



200 Dining Table
2EQ20.700 Slate Grey (p. 72)

- 200cm - 78 3/4"
- 71cm - 28"
- 90cm - 35 1/2"
- 42kg - 92lbs
- 8
- 4SO35R

Laminate Top



150 Dining Table with Lazy Susan
2EQC15.700 Slate Grey

- Ø 150cm - 59"
- 73cm - 28 3/4"
- 53kg - 117lbs
- 6 - 8
- 4SO35C

Laminate Top

Lazy Susan

- Ø 69.5cm - 27 1/4"
- Laminate Top



180 Dining Table with Lazy Susan
2EQC18.700 Slate Grey (p. 70)

- Ø 180cm - 70 3/4"
- 73cm - 28 3/4"
- 73.5kg - 162lbs
- 8 - 10
- 4SO40C

Laminate Top

Lazy Susan

- Ø 84.5cm - 33 1/4"
- Laminate Top

For cushion colours see page 174



Armchair
1EQDA (p. 80)

- 74cm - 29 1/4"
- 81.5cm - 32 1/4"
- 94cm - 37"
- 19kg - 42lbs



Two Seat Settee
1EQD2 (p. 80)

- 138cm - 54 1/4"
- 81.5cm - 32 1/4"
- 94cm - 37"
- 30kg - 66lbs

stainless steel

equinox

316 grade stainless steel



Three Seat Settee
1EQD3 (p. 80)

202cm - 79 1/2"
81.5cm - 32 1/4"
94cm - 37"
42kg - 92lbs



Ottoman
1EQDO (p. 80)

74cm - 29 1/4"
44.5cm - 17 1/2"
70.5cm - 27 3/4"
12.5kg - 27.5lbs

mercury

316 grade stainless steel

For sling and armrest colours see page 177



56cm - 22"
90cm - 35 1/2"
57cm - 22 1/2"
6.5kg - 14lbs

Stacking Armchair (p. 82)

Armrest	Sling
1MEA.01.500 Graphite	-Charcoal
1MEA.01.502 Graphite	- Titanium
1MEA.01.504 Graphite	- Platinum
1MEA.02.501 Arctic White	- White
1MEA.02.503 Arctic White	- Aquamarine
1MEA.500 Teak	- Charcoal
1MEA.501 Teak	- White
1MEA.502 Teak	- Titanium
1MEA.503 Teak	- Aquamarine
1MEA.504 Teak	- Platinum

For glass top colours see page 178

Without parasol hole



120 Dining Table
2MEC12.604 Sea Ice
2MEC12.605 Platinum
2MEC12.606 Charcoal

Ø 120cm - 47 1/4"
74cm - 29 1/4"
28.5kg - 63lbs
4 - 6

Glass top

For glass top colours see page 178

Without parasol hole



220 Dining Table (p. 84)

2ME22.604 Sea Ice
2ME22.605 Platinum
2ME22.606 Charcoal

220cm - 86 1/2"
74cm - 29 1/4"
101cm - 39 3/4"
72kg - 158lbs
6

Glass top

For ceramic top colour see page 178



Serving Table
2MES (p. 88)

122cm - 48"
94cm - 37"
59.5cm - 23 1/4"
53kg - 117lbs

Ceramic top

quattro

304 grade stainless steel

For sling colours see page 177



55cm - 21 1/2"
83.5cm - 33"
64cm - 25 1/4"
7.5kg - 17lbs

Stacking Armchair (p. 90)

Armrest	Sling
1QUA.01.500 Graphite	- Charcoal
1QUA.01.502 Graphite	- Titanium
1QUA.01.504 Graphite	- Platinum
1QUA.02.501 Arctic White	- White
1QUA.02.503 Arctic White	- Aquamarine
1QUA.500 Teak	- Charcoal
1QUA.501 Teak	- White
1QUA.502 Teak	- Titanium
1QUA.503 Teak	- Aquamarine
1QUA.504 Teak	- Platinum



Lounger (p. 92)

1QUL.500 Charcoal
1QUL.501 White
1QUL.502 Titanium
1QUL.503 Aquamarine
1QUL.504 Platinum

196.5cm - 77 1/4"
30cm - 11 3/4"
75cm - 29 1/2"
15kg - 33lbs

For laminate top colour see page 178



Lounger Sun Shade
(p. 92)

1LSS.500 Charcoal
1LSS.501 White
1LSS.502 Titanium
1LSS.503 Aquamarine
1LSS.504 Platinum

62cm - 24 1/2"
35cm - 13 3/4"
1kg - 2.4lbs



Lounger Side Table
2QULT.700 Slate Grey (p. 92)

35cm - 13 3/4"
30cm - 11 3/4"
35cm - 13 3/4"
3kg - 6.5lbs

Laminate top

stainless steel

quattro

304 grade stainless steel

For laminate top colour see page 178

Without parasol hole



100 Dining Table
2QU10.700 Slate Grey (p. 63)

- 95cm - 371/2"
- 73cm - 283/4"
- 95cm - 371/2"
- 22kg - 48.5lbs
- 2 - 4

Laminate top

Without parasol hole



200 Dining Table
2QU20.700 Slate Grey

- 187.5cm - 733/4"
- 73cm - 283/4"
- 95cm - 371/2"
- 40kg - 88lbs
- 6 - 8

Laminate top

aluminium

aura



Stacking Armchair (p. 96)

	Frame	Sling
1AUA.01.500	Graphite	- Charcoal
1AUA.01.502	Graphite	- Titanium
1AUA.01.504	Graphite	- Platinum
1AUA.02.501	Arctic White	- White
1AUA.02.503	Arctic White	- Aquamarine

- 58cm - 223/4"
- 90.5cm - 353/4"
- 66cm - 26"
- 6.5kg - 14lbs

For frame colours see page 177



90 Dining Table (p. 97)

	Frame
2AU09.01	Graphite
2AU09.02	Arctic White

- 90cm - 351/2"
- 74cm - 29"
- 90cm - 351/2"
- 17.5kg - 38lbs
- 4
- 4VE30R, 4VE30C



150 Dining Table (p. 96)

	Frame
2AU15.01	Graphite
2AU15.02	Arctic White

- 145cm - 57"
- 74cm - 29"
- 90cm - 351/2"
- 24kg - 53lbs
- 4 - 6
- 4VE30R



200 Dining Table

	Frame
2AU20.01	Graphite
2AU20.02	Arctic White

- 200cm - 783/4"
- 74cm - 29"
- 90cm - 351/2"
- 30.5kg - 67lbs
- 4 - 6
- 4SO35R

eclipse



Stacking Armchair (p. 98)

	Frame	Sling
1ECA.01.500	Graphite	- Charcoal
1ECA.01.502	Graphite	- Titanium
1ECA.01.504	Graphite	- Platinum
1ECA.02.501	Arctic White	- White
1ECA.03.504	Quicksilver	- Platinum

- 62cm - 241/2"
- 92cm - 361/4"
- 63.5cm - 25"
- 7kg - 15lbs

For frame and sling colours see pages 176/177



Lounger (p. 103)

	Frame	Sling
1ECL.01.500	Graphite	- Charcoal
1ECL.01.502	Graphite	- Titanium
1ECL.01.504	Graphite	- Platinum
1ECL.02.501	Arctic White	- White
1ECL.03.504	Quicksilver	- Platinum

- 202cm - 791/2"
- 30.5cm - 12"
- 78cm - 303/4"
- 14kg - 31lbs



Lounger Side Table (p.103)

	Frame
2ECLT.01	Graphite
2ECLT.02	Arctic White
2ECLT.03	Quicksilver

- 47cm - 181/2"
- 32.5cm - 123/4"
- 28.5cm - 111/4"
- 3.5kg - 8lbs

aluminium

eclipse

For frame colours see page 177



120 Dining Table (p. 99)

Frame
2ECC12.01 Graphite
2ECC12.02 Arctic White
2ECC12.03 Quicksilver

- Ø 125cm - 49 1/4"
- ┌┐ 70cm - 27 3/4"
- ⚖ 21kg - 46lbs
- 👤 4-6
- ⚙ 4SI25C



200 Dining Table (p.102)

Frame
2EC20.01 Graphite
2EC20.02 Arctic White
2EC20.03 Quicksilver

- ▢ 197.5cm - 77 3/4"
- ┌┐ 70cm - 27 3/4"
- ▢ 104cm - 41"
- ⚖ 30kg - 66lbs
- 👤 6-8
- ⚙ 4SQ35R

loop



Stacking Armchair (p. 104)

Frame Sling
1LPA.01.500 Graphite - Charcoal
1LPA.01.504 Graphite - Platinum
1LPA.01.502 Graphite - Titanium
1LPA.02.501 Arctic White - White
1LPA.03.504 Quicksilver - Platinum

- 👤
- ▢ 57.5cm - 22 1/2"
- ┌┐ 93.5cm - 36 3/4"
- ┌┐ 62cm - 24 1/2"
- ⚖ 5kg - 11lbs

For frame and sling colours see page 176/177



Stacking Sun Lounger (p. 106)

Frame Sling
1LPL.01.500 Graphite - Charcoal
1LPL.01.504 Graphite - Platinum
1LPL.01.502 Graphite - Titanium
1LPL.02.501 Arctic White - White
1LPL.03.504 Quicksilver - Platinum

- 👤
- ↔ 200cm - 78 3/4"
- ↔ 30.5cm - 12"
- ▢ 64cm - 25 1/4"
- ⚖ 12.5kg - 28lbs

Optional lounger armrests available in the following colours: (p. 106)

1LPLA.01 Graphite
1LPLA.02 Arctic White
1LPLA.03 Quicksilver



Sun Lounger Side Table (p. 106)

Frame
2LPLT.01 Graphite
2LPLT.02 Arctic White
2LPLT.03 Quicksilver



- ▢ 39.5cm - 15 3/4"
- ┌┐ 30.5cm - 12"
- ▢ 39.5cm - 15 3/4"
- ⚖ 5kg - 11lbs



160 Dining Table (p. 105)

Frame
2LP16.01 Graphite
2LP16.02 Arctic White
2LP16.03 Quicksilver

- ▢ 156.5cm - 61 3/4"
- ┌┐ 74cm - 29 1/4"
- ▢ 96.5cm - 38"
- ⚖ 30kg - 66lbs
- 👤 4-6
- ⚙ 4VE30R

arizona

Cushion colours
page 174

Weave and colour
samples page 177



Armchair
601351 Sahara
601361 Java (p. 110)

☰ 104cm - 41"
☱ 76cm - 30"
☱ 104cm - 41"
⚖ 26.5kg - 58lbs



104 Ottoman
601350 Sahara
601360 Java (p. 110)

☰ 104cm - 41"
☱ 40cm - 15 3/4"
☱ 104cm - 41"
⚖ 19kg - 42lbs



76 Ottoman
601352 Sahara
601362 Java

☰ 76cm - 30"
☱ 40cm - 15 3/4"
☱ 76cm - 30"
⚖ 11kg - 24lbs



Left Hand Unit
601354 Sahara (p. 111)
601364 Java (p. 110)

☰ 104cm - 41"
☱ 76cm - 30"
☱ 104cm - 41"
⚖ 16kg - 35lbs



Right Hand Unit
601355 Sahara (p. 111)
601365 Java (p. 110)

☰ 104cm - 41"
☱ 76cm - 30"
☱ 104cm - 41"
⚖ 16kg - 35lbs



Corner Unit
601356 Sahara (p. 112)
601366 Java (p. 115)

☰ 104cm - 41"
☱ 76cm - 30"
☱ 104cm - 41"
⚖ 17kg - 37lbs



Center Unit
601357 Sahara (p. 112)
601367 Java (p. 115)

☰ 76cm - 30"
☱ 76cm - 30"
☱ 104cm - 41"
⚖ 12kg - 26lbs



End Table
601652 Sahara
601662 Java (p. 115)

☰ 47cm - 18 1/2"
☱ 60cm - 23 1/2"
☱ 47cm - 18 1/2"
⚖ 9kg - 20lbs



76 Coffee Table
601650 Sahara (p. 114)
601660 Java

☰ 76cm - 30"
☱ 46cm - 18"
☱ 76cm - 30"
⚖ 12.5kg - 28lbs



120 Coffee Table
601651 Sahara
601661 Java (p. 115)

☰ 120cm - 47 1/4"
☱ 46cm - 18"
☱ 76cm - 30"
⚖ 17kg - 37lbs

woven

dune

Cushion colours
page 174

Weave and colour
samples page 177



Armchair
602351 Straw
602361 Java (p. 118)

- ☰ 102cm - 40 1/4"
- ┌┐ 83cm - 32 3/4"
- ┌┐ 95cm - 37 1/2"
- ⚖ 21.7kg - 48lbs



Conversation Table
602650 Straw
602660 Java (p. 118)

- ∅ 100cm - 39 1/4"
- ┌┐ 48cm - 18 3/4"
- ⚖ 22.5kg - 49lbs
- Glass top



Two Seat Settee
602352 Straw
602362 Java (p. 119)

- ☰ 162cm - 64"
- ┌┐ 83cm - 32 3/4"
- ┌┐ 95cm - 37 1/2"
- ⚖ 34kg - 75lbs



Daybed and Ottoman
602700 Straw (p. 117)
602750 Java (p. 116)

- ☰ 189cm - 74 1/2"
- ┌┐ 81.5cm - 32"
- ┌┐ 130cm - 51 1/4"
- ⚖ 48kg - 106lbs



- ☰ 140cm - 55"
- ┌┐ 35.5cm - 14"
- ┌┐ 62cm - 24 1/2"

nevada

Cushion colours
page 174

Weave and colour
samples page 177



Armchair
605100 (p. 120)

- ☰ 57.5cm - 22 3/4"
- ┌┐ 82.5cm - 32 1/2"
- ┌┐ 66cm - 26"
- ⚖ 8.5kg - 19lbs
- 📦 800080



Armchair
605351 (p. 122)

- ☰ 73cm - 28 3/4"
- ┌┐ 81cm - 32"
- ┌┐ 86cm - 33 3/4"
- ⚖ 12.5kg - 28lbs



Three Seat Settee
605353 (p. 123)

- ☰ 203cm - 80"
- ┌┐ 86cm - 32 1/4"
- ┌┐ 94cm - 37"
- ⚖ 29.5kg - 65lbs

woven

nevada



Ottoman
605350

- 73cm - 283/4"
- 37cm - 14 1/2"
- 69cm - 27 1/4"
- 5kg - 11lbs



Sun Lounger
605470 (p. 124)

- 199.5cm - 78 1/2"
- 27cm - 10 3/4"
- 82cm - 32 1/4"
- 24kg - 53lbs

savannah

Cushion colours
page 174

Weave and colour
samples page 177



Dining Side Chair
603171 (p. 128)

- 46.5cm - 18 1/4"
- 95cm - 37 1/2"
- 65.5cm - 25 3/4"
- 5.5kg - 12lbs
- 800064



Dining Armchair
603100 (p. 126)

- 61cm - 24"
- 95cm - 37 1/2"
- 65.5cm - 25 3/4"
- 8kg - 17lbs
- 800056



Armchair
603351 (p. 130)

- 77.5cm - 30 1/2"
- 97.5cm - 38 1/2"
- 87cm - 34 1/4"
- 15kg - 33lbs



Ottoman
603350 (p. 131)

- 62cm - 24 1/2"
- 41cm - 16 1/4"
- 62cm - 24 1/2"
- 7kg - 15lbs



Two Seat Settee
603352 (p. 131)

- 140.5cm - 55 1/4"
- 97.5cm - 38 1/2"
- 87cm - 34 1/4"
- 25kg - 55lbs



Three Seat Settee
603353 (p. 131)

- 200.5cm - 79"
- 97.5cm - 38 1/2"
- 87cm - 34 1/4"
- 33.5kg - 74lbs

Cushion colours
page 174

Weave and colour
samples page 177



Sun Lounger
603470 (p. 132)

- 208.5cm - 82"
- 33cm - 13"
- 75.5cm - 29 3/4"
- 19.5kg - 43lbs
- 800062



Sun Lounger Side Table
603700 (p. 132)

- 49cm - 19 1/4"
- 30.5cm - 12"
- 35cm - 13 3/4"
- 4.5kg - 10lbs
- Clear glass top



40 End Table
603670 (p. 131)

- 46.5cm - 18 1/4"
- 54cm - 21 1/4"
- 46.5cm - 18 1/4"
- 7.5kg - 17lbs
- Clear glass top



95 Coffee Table
603650

- 96.5cm - 38"
- 42cm - 16 1/2"
- 63.5cm - 25"
- 16.5kg - 36lbs
- Clear glass top



150 Coffee Table
603651 (p. 131)

- 150.5cm - 59 1/4"
- 42cm - 16 1/2"
- 96.5cm - 38"
- 35.5kg - 78lbs
- Clear glass top



120 Dining Table
603522

- 125cm - 49 1/4"
- 71.5cm - 28 1/4"
- 19.5kg - 43lbs
- 4
- 4SI25C
- Clear glass top



150 Dining Table
603524 (p. 127)

- 145.5cm - 57 1/4"
- 71.5cm - 28 1/4"
- 24kg - 53lbs
- 6
- 4MI35C, 4SO35C
- Clear glass top



200 Dining Table
603565 (p. 128)

- 197.5cm - 77 3/4"
- 72.5cm - 28 1/2"
- 104cm - 41"
- 37.5kg - 83lbs
- 8
- 4MI35R, 4SO35R
- Clear glass top

material selection
furniture covers
inscriptions

security
product care
faqs

cushions

We manufacture our cushions using Sunbrella® fabric, made from a durable, 100% solution dyed acrylic fibre that is very colour fast in sunlight. A stain repellent is applied to the fabric, although it will withstand vigorous cleaning if necessary.

Our cushions have a water repellent finish but are not waterproof and should not be left out in heavy rain. If cushions become saturated, then place them on one edge and allow the water to drain away until they are thoroughly dry. Do not store cushions when they are wet.

USA only: COM and other colours to special order. Cushion colours depicted may be different in the USA.

stock colours



.5446 Forest Green

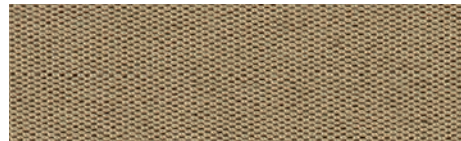

.5476 Pepper

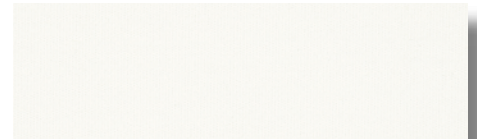

.5404 White Sand

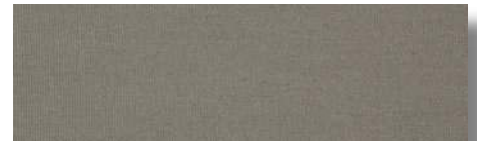

.3729 Taupe

optional colours



.5439 Classic Blue



.3705 Charcoal



.5424 Sky Blue



.3738 Macaw



.3728 Paris Red



.5408 Black



.5470 Walnut



.5629 Sky Blue Stripe



.3747 Macaw Stripe



.3756 Lead Chiné



.3778 Quadr Grey

cushions

Ref.	Cushion Type	To fit the following products	5446	5404	5476	3729	5408	3705	5470	5439	5424	5629	3778	3756	3728	3738	3747
800001	Armchair	1FEA, 1GLA, 1LOA, 1MOA, 1PRA, 1WAA	■	■	■	■	○	○	○	○	○	○	○	○	○	○	○
800002	Hi-Back Chair	1ASR, 1COC, 1NER	■	■	■	■	○	○	○	○	○	○	○	○	○	○	○
800003	Hi-Back Chair - Seat pad	1ASR, 1COC, 1NER	■	■	■	■	○	○	○	○	○	○	○	○	○	○	○
800004	Dining Chair	1AS, 1ASC, 1MOF, 1MOCF	■	■	■	■	○	○	○	○	○	○	○	○	○	○	○
800005	Dining Chair - Large	1APA, 1EQ.T, 1EQAT, 1LIA, 1MO, 1MOCH, 1MOH, 1PR	■	■	■	■	○	○	○	○	○	○	○	○	○	○	○
800006	Sun Loungers	1CAB, 1CAS, 1CAU, 1EQLT, 1MOL	■	■	■	■	○	○	○	○	○	○	○	○	○	○	○
800008	Horizon Armchair	1HOAS.T	■	■	■	■	○	○	○	○	○	○	○	○	○	○	○
800012	120cm Seat	1FE12, 1MO12, 1WA12	■	■	■	■	○	○	○	○	○	○	○	○	○	○	○
800015	150cm Seat	1FE15, 1GL15, 1LO15, 1MO15, 1WA15	■	■	■	■	○	○	○	○	○	○	○	○	○	○	○
800018	180cm Seat	1GL18, 1LO18	■	■	■	■	○	○	○	○	○	○	○	○	○	○	○
800056	Savannah Armchair	603100	○	■	○	○	○	○	○	○	○	○	○	○	○	○	○
800064	Savannah Side Chair	603171	○	■	○	○	○	○	○	○	○	○	○	○	○	○	○
800062	Savannah Sun Lounger	603470	○	■	○	○	○	○	○	○	○	○	○	○	○	○	○
800066	Steamer Chair	1CO	■	■	■	■	○	○	○	○	○	○	○	○	○	○	○
800067	Steamer Chair	1CO67W	■	■	■	■	○	○	○	○	○	○	○	○	○	○	○
800080	Nevada Armchair	605100	○	■	○	■	○	○	○	○	○	○	○	○	○	○	○
800087	Armchair Slip Over Cushion	1APA, 1LIA	○	■	○	○	○	○	○	○	○	○	■	■	○	○	○
800041	Ascot Footstool	1ASFS	■	■	■	■	○	○	○	○	○	○	○	○	○	○	○
800007	Lumbar Cushion 51 x 20cm	All	■	■	■	■	○	○	○	○	○	○	○	○	○	○	○
800050	Scatter Cushion 50 x 50cm	All	■	■	■	■	○	○	○	○	○	○	○	○	○	○	○
800060	Scatter Cushion 60 x 60cm	All	■	■	■	■	○	○	○	○	○	○	○	○	○	○	○
800070	Scatter Cushion 70 x 70cm	All	■	■	■	■	○	○	○	○	○	○	○	○	○	○	○
Arizona Collection		601351, 601361, 601356, 601366, 601355, 601365, 601354, 601364, 601357, 601367, 601350, 601360, 6013521, 601362	○	■	○	○	○	○	○	○	○	○	○	○	○	○	○
Dune Collection		602700, 602750, 602351, 602361, 602352, 602362	○	■	○	○	○	○	○	○	○	■	■	○	○	○	○
Equinox Deep Seating Collection		1EQDA, 1EQD2, 1EQD3, 1EQDO	○	○	○	○	○	■	○	○	○	○	○	○	○	○	○
Haven Deep Seating Collection		1HADA, 1HADMM, 1HADML, 1HADMR, 1HADMC, 1HALA, 1HAO	○	■	■	○	○	○	○	○	○	○	○	○	○	○	○
Mission Collection		1MIA, 1MIFS	○	■	■	○	○	○	○	○	○	○	○	○	○	○	○
Savannah Collection		603352, 603353, 603351, 603350	○	■	○	○	○	○	○	○	○	○	○	○	○	○	○
Nevada Deep Seating Collection		605351, 605353, 605470	○	■	○	■	○	○	○	○	○	○	○	○	○	○	○

■ Stock Colours

○ Optional Colours

Please allow five weeks delivery for Optional Colours

parasols

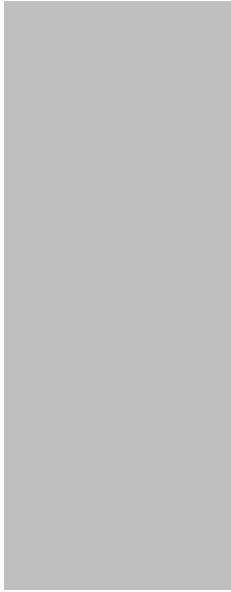

Parasol canopy fabrics are made from solution-dyed acrylic yarn, with the colour locked deep inside the yarn to give excellent resistance to the fading often caused by sunlight and cleaning. A stain repellent has been to the fabric to make cleaning easier.



.300 Forest Green



.306 Oyster



.308 Black (Special order only in USA)

pavilions

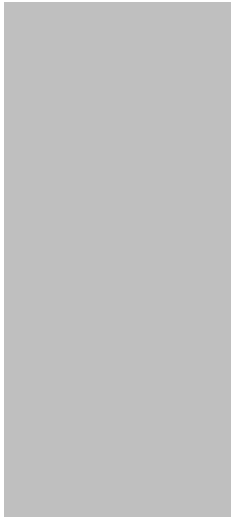

The Pavilion roof and full curtains are made from Sunbrella®100% solution-dyed acrylic yarn, with the colour locked deep inside the yarn to give excellent resistance to the fading often caused by sunlight and cleaning.



.1275 Stone



.4781 Chocolate



.4642 Oyster

slings

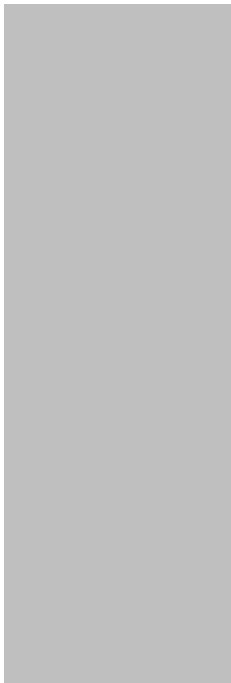

The slings on our furniture are made from Textilene®, which is woven from PVC coated polyester non-stretch yarn. This material guarantees our slings are strong, durable, and mildew resistant requiring the minimum of maintenance.

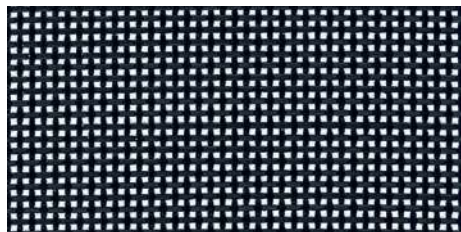

.500 Charcoal (Equinox, Eclipse, Horizon, Loop, Mercury, Quattro)

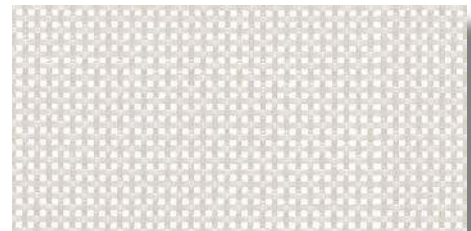

.501 White (Equinox, Eclipse, Horizon, Loop, Mercury, Quattro)



.502 Titanium (Equinox, Eclipse, Horizon, Loop, Mercury, Quattro)

slings

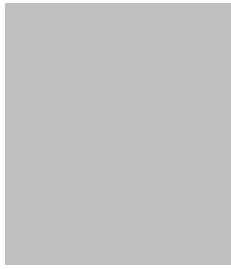

aluminium

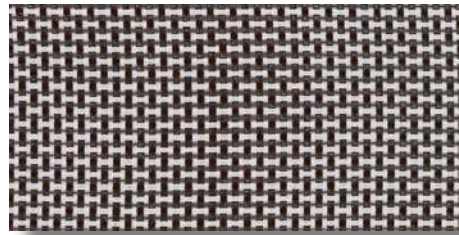
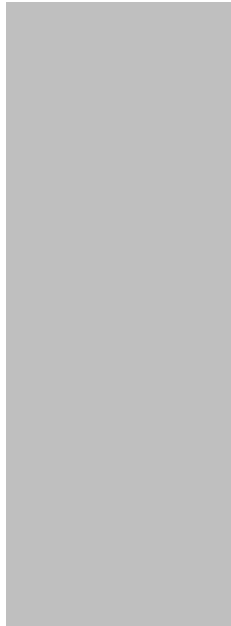

.504 Platinum
(Equinox, Eclipse, Horizon, Loop, Mercury, Quattro)

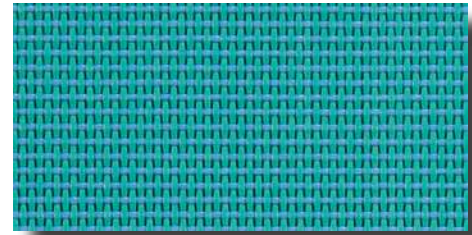

.503 Aquamarine
(Equinox, Horizon, Mercury, Quattro)

For our aluminium furniture we use what is known as "Virgin Aluminium". We chemically clean each item and then powder-coat the aluminium to prevent oxidation and to ensure it gives long service.



.02 Arctic White
Frames: Aura, Eclipse, Loop
Arm Inserts: Equinox, Mercury, Quattro



.01 Graphite
Frames: Aura, Eclipse, Loop
Arm Inserts: Equinox, Mercury, Quattro

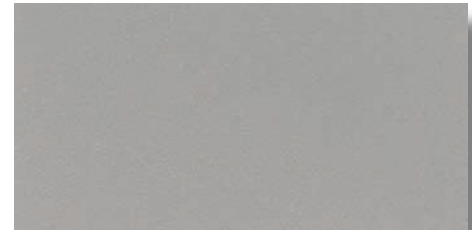

.03 Quicksilver
Frames: Eclipse, Loop

woven

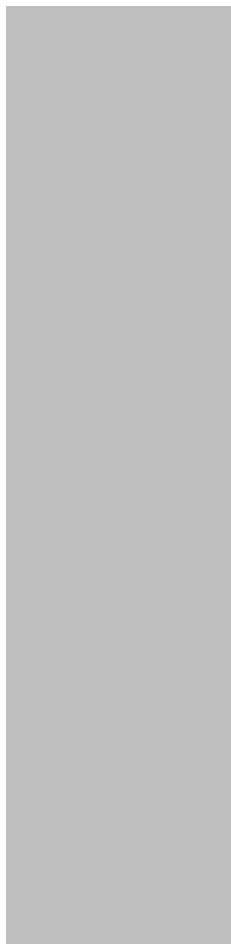

We use a synthetic fibre that is colour fast, exceptionally strong and completely resistant to sun, rain and requires the minimum of maintenance.



Java - Flat (Savannah)



Cinnamon (Nevada)



Sahara (Arizona)



Java (Arizona)



Java - Round (Dune)



Straw (Dune)

table tops

glass

Although made to withstand the rigours of an outdoor environment, your furniture will benefit from regular care and maintenance. For each type of our furniture, we produce a care product that is easy to use and will help maintain its 'just bought' look. Normally, you will need to treat your furniture only once or twice a year, dependent upon location.

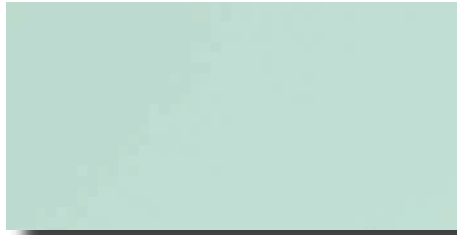

.604 Sea Ice (*Mercury*)

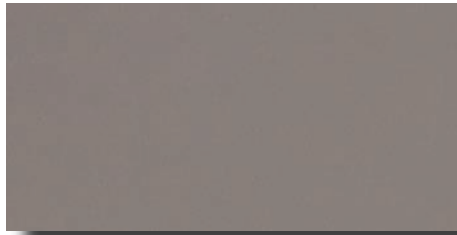

.605 Platinum (*Mercury*)



.606 Charcoal (*Mercury*)

Our Mercury dining table tops are made from clear tempered glass with the colour applied to the under surface with a hard wearing ceramic paint. The top surface has been acid etched and sand blasted to achieve a luxurious tactile matt surface.

high pressure laminate (HPL)

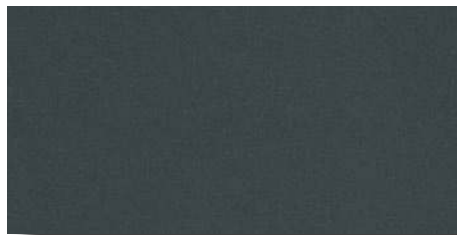

.700 Slate Grey (*Equinox, Mercury*)

Our HPL (High Pressure Laminate) table tops are unaffected by rain, sun, mold or rot. They have high colour stability and are UV resistant. The surface has a smooth, wipe clean finish that ensures dirt does not accumulate.

ceramic



Grey (*2MES Mercury Serving Table only*)

The Laminam ceramic we use is weather resistant, has high colour stability, wipe clean finish and is scratch proof. The ideal outdoor work surface.

covers

These lightweight, one way breathable covers allow trapped moisture to disperse, but prevent rain and dust from penetrating. A unique fastening ensures a secure fit. The covers are easy to put on, remove and can be stored in their own pouch when not required.



Code	Description	To Fit
Arizona Range Covers		
400101	Arizona Armchair	601351, 601361
400102	Arizona 2 Seater combination	601354 + 601355, 601364 + 601365
400103	Arizona 3 Seater combination	601354 + 601357 + 601355, 601364 + 601367 + 601365
400782	Arizona Large Ottoman	601350, 601360
400118	Arizona End Table	601652, 601662
400130	Arizona 75cm Coffee Table	601650, 601660
400147	Arizona 120cm Coffee Table	601651, 601661
Dune Range Covers		
400700	Dune Daybed and Ottoman	602700, 602750
400701	Dune Deep Seating Armchair	602351, 602361
400702	Dune Deep Seating 2 Seater	602352, 602362
400781	Circular Conversation Table	602650, 602660
Nevada Range Covers		
400501	Nevada Deep Seating Armchair	605351
400503	Nevada Deep Seating 3 Seater	605353
High Back Deep Seating Covers		
400721	High Back Deep Seating Armchair	603351, 1ADA, 1HADA, 1MIA
400722	High Back Deep Seating 2 Seater	603352
400723	High Back Deep Seating 3 Seater	603353
Sun Lounger Covers		
400731	Sun Loungers	All Sun Loungers
Standard Deep Seating Covers		
400741	Standard Height Deep Seating Armchair	1EQDA
400742	Standard Height Deep Seating 2 Seater	1EQD2, 1HADML + 1HADMR
400743	Standard Height Deep Seating 3 Seater	1EQD3, 1HADML + 1HADMM + 1HADMR
400130	Deep Seating Ottoman	1EQDO
Standard Dining Group Covers		
400751	90cm to 120cm Table and 4 Chairs	2AU09, 2ED09, 2EQ09.700, 2EQC10, 2AR09, 2EQ10, 2BA11, 2BA13, 2ECC12, 2MEC12, 2QU10, 603522
400752	90cm Circular High Dining and 4 Chairs	2EDH09, 2EQCH10
400754	150cm to 180cm Circular Table and 8 Chairs	2DR15, 2EQC15S, 2EQC18.700, 2EQ15.700, 2HOC15, 2HOC18, 2WIC15, 603524, 2DR18, 2EQC18S
400765	150cm Rectangular Table and 6 Chairs	2AU15, 2AR13, 2ME15T, 2MO15, 2W115, 2EQ15, 2EQ15.700, 2EQX23 (closed), 2LP16
400766	200cm Rectangular Table and 6 - 8 Chairs	2AU20, 2AR18, 2ARX28 (closed), 2EQ15.700, 2EQ20.700, 2EQ22, 2ST20, 2EC20, 2ME22, 2QU20, 603565, 604565
400767	320cm Rectangular Table and 8 - 10 Chairs	2STX32 (closed)
400768	Apex Extending Table and 14 Chairs	2APX39
Accessory Covers		
400770	Serving Table and Trolley	2CR, 2EQS, 2MES, 2MIS
400772	Small Storage Chest	3SC11
400773	Large Storage Chest	3SC15
400774	Reims Refreshment Chest	3RE
Conversation/Coffee Tables		
400781	Circular Conversation Table	602650, 602660, 2EQCC10, 2HACC10
400782	Square Conversation Table	2EQSC10, 2HASC10
400783	Small Rectangular Coffee Table	603650, 2EQL10, 2MOL, 2MOL10
400784	Large Rectangular Coffee Table	603651

inscriptions



The Barlow Tyrie inscription service may be used with most of our teak Armchairs and Seats. The inscription is normally on the front of the top rail.



The carving is in a traditional serif typeface using a 'V' shaped cut, which allows the inscription to be easily read from the side as well as from immediately in front. A 'straight' cut letter does not have this advantage.



As an alternative to carved inscriptions we also offer Bronze Plaques with lettering set in cream vitreous enamel. The finished plaque is then recessed into the face of the rail and held in position using a special hidden vandal proof fitting.

security



Galvanised seat security fasteners for setting into concrete for all teak seat models to prevent unauthorised movements of seats in public areas.



A set of four polished brass seat security fasteners to prevent unauthorised movements of seats in public areas. Supplied with tamper proof fixings for concrete, paving and wood.

product care

Although made to withstand the rigours of an outdoor environment, your furniture will benefit from regular care and maintenance. For each type of our furniture, we produce a care product that is easy to use and will help maintain its 'just bought' look. Normally, you will need to treat your furniture only once or twice a year, dependent upon location.

However, harsher environments such as coastal or chlorinated pool areas may need more frequent maintenance. Spotting on the surface, which appears to be rust, may occur, although unsightly, you can easily remove any contamination with "Barlow Tyrie Stainless Steel Clean and Guard", which cleans the stainless steel and leaves a fine layer of Teflon® on the surface to help prevent the build up of contaminants.

Stainless Steel Clean & Guard



Ref. 4SSCG
Cleans stainless steel and leaves a fine layer of Teflon on the surface to help prevent the build up of contaminants. Supplied with its own special applicator pad.

Contains 1litre/33oz

Teak Cleaner



Ref. 4TC
Cleans and restores discoloured, dark grey teak. Contains brightener ingredients which will restore your teak to its original colour. Supplied with its own special applicator pad.

Contains 1litre/33oz

Powder Coated Aluminium Cleaner



Ref. 4AC
Easily removes dirt and grease, oil, pollutants and mould from the furniture. Supplied with its own special applicator pad.

Contains 1litre/33oz

Teak Stain Guard



Ref. 4TSG
Forms an invisible layer to protect your teak from everyday stains such as butter, oil and red wine, making the cleaning of accidental spills an easy task. Supplied with its own special applicator pad.

Contains 1litre/33oz

Textilene & Woven Non Foam Cleaner



Ref. 4WTC
A non foaming cleaner that maintains woven furniture and Textilene® without unsightly residue remaining after the cleaning process. Supplied with its own special applicator pad.

Contains 1litre/33oz

Teak Colour Guard



Ref. 4TCG
Maintains the golden brown colour of new teak. Supplied with its own special applicator pad.

Contains 1litre/33oz

Fabric Cleaner



Ref. 4FC
Removes dirt and grease, oil, pollutants and mould from our cushions. Supplied with its own special applicator pad.

Contains 1litre/33oz

Teak Oil



Ref. 4TO
Traditional method of retaining original colour of new teak.

Contains 500ml/16oz

Fabric Weather Guard



Ref. 4FWG
Protects the fabric and slows down the aging effects of weathering. Supplied with its own special applicator pad.

Contains 1litre/33oz

Anti Wasp Solution



Ref. 4WS
Deters wasps from defacing the surface of weathered wood.

Contains 1litre/33oz

Note: Not available in the USA

Which materials does Barlow Tyrie use?

We combine the highest quality materials with superior craftsmanship and design to produce our furniture, resulting in worldwide recognition of our brand as representing the best in outdoor furniture. To our renowned range of the highest grade teak furniture we have now added Textilene®, stainless steel, aluminium and synthetic woven materials, to produce contemporary designs to the same high standard.

Teak
What are the properties of teak?

Teak is a deciduous hardwood tree from managed plantations, it does not come from tropical rainforests. Teak has a naturally high oil content which makes it both stable and resistant to rotting when exposed to climatic extremes. For centuries these special qualities have made teak the preferred choice for marine decking and construction, hence it is considered the premium timber for outdoor furniture.

What is the Forest Stewardship Council (FSC) ?

The Forest Stewardship Council is an international, non-profit association whose members include environmental, social groups, progressive forestry and timber related companies who are working together in order to improve forest management world-wide. The trademark of the FSC on a product indicates that the wood used to make it comes from a source that has been certified by the FSC as being well managed and meeting the environmental, social and economic standards that have been set by the FSC. The FSC certificate is only granted to organisations following an annual audit to confirm their compliance with FSC standards. Our audit is performed by an FSC accredited audit organisation called Smartwood and our Chain of Custody code is SW-COC-000090.

Does Barlow Tyrie produce any FSC certified furniture ?

Yes. Selected products displayed in store and held in stock are FSC certified, as are the stocks held at Barlow Tyrie on the behalf of John Lewis. Other products, which may be ordered from the Barlow Tyrie range may not be FSC certified.

What is the teak weathering process ?

Over a period of time in an outdoor environment teak will weather to a beautiful silver grey. The length of time this takes will vary with exposure to different climatic conditions.

Why do occasional cracks appear on my furniture ?

Teak is a natural material and as such fine cracks in the end grain of components, e.g. legs and arms, may appear and then disappear with variations in the weather and the consequent change in the moisture content of the wood. Such fine cracks are normal, especially in heavier components, and will not affect the life or serviceability of your furniture.

Do I need to store my furniture during the winter ?

No, Barlow Tyrie teak furniture can be left outdoors, uncovered, all year round. If you choose to cover your furniture outdoors during the winter you should use a material that allows the wood to breathe.

Stainless Steel
What are the properties of stainless steel?

We use two grades of stainless steel; 316 Grade, commonly known as 'marine grade' and 304 Grade, the most commonly used for garden furniture. 316 and 304 grades are both suitable for use in inland locations, but 316 grade is suited for most coastal areas and marine environments. 304 and 316 grade should not be used in heavily chlorinated indoor environments.

If you have any questions or concerns about which grade is best suited for your area, please contact customer service.

We recommend the following Barlow Tyrie product to care for and maintain your Stainless Steel furniture

- *Stainless Steel Clean & Guard*
 Cleans stainless steel and leaves a fine layer of Teflon on the surface to help prevent the build up of contaminants.

Aluminium
What are the properties of aluminium?

Aluminium is lightweight and for this reason, we have included it in our range. The aluminium we use is 'Virgin Aluminium', meaning it is not reclaimed from scrap, making it stronger and longer lasting. We powder-coat the aluminium to prevent oxidation and ensure it gives long service. We recommend the following Barlow Tyrie product to care for and maintain your Aluminium furniture

- *Powder Coated Aluminium Cleaner*
 Easily removes dirt, grease, oil, pollutants and mould.

Care of teak
How do you clean teak?

Teakwood will naturally weather from golden brown to a silver grey colour. We recommend the following range of our Barlow Tyrie products to care for and maintain your Teak furniture.

- *Teak Cleaner*
 Will quickly remove accumulated dirt
- *Teak Stain Guard*
 Forms an invisible layer to protect your teak from everyday stains such as butter, oil and red wine, making the cleaning of accidental spills an easy task.
- *Teak Colour Guard*
 Will maintain the golden brown colour of new teak by using UV inhibitors to prevent the natural greying process and pigment enhancers to help maintain the natural colour of teak.

If you live in the UK and wish to maintain your furniture using our care products, but do not wish to do the work yourself, then we recommend you contact www.teakcare.co.uk who can provide a regular or one time service according to your needs

Do I need to oil my teak furniture?

Treating with teak oil or other preservatives is not necessary, it will not extend the life of your furniture and is purely cosmetic. We do not recommend oiling your furniture.

Will the metal fittings on my furniture last as long as the teak?

We only use the best marine quality solid brass and stainless steel on our furniture. Neither of these will rust nor deteriorate with age.

Do I need to use a base if I am locating a parasol through a dining table?

Yes, all parasols must be located in the recommended parasol base for safety reasons. We supply our standard parasol base for when you wish to use a parasol through a dining table, a free standing base is available for use without a table. Standard parasol plates are available for when a parasol is required for the Equinox Pedestal Tables.

Can we use any of your chairs with any of your tables?

Our dining chairs and tables are made to a standard that gives the correct distance between the seat and the table top, which ensures you are comfortable when eating. You can confidently purchase any of our chairs with any of our tables depending on your design preference and the number of people you wish to seat.



© Copyright Barlow Tyrie Limited

1EQA.500 2EQC18S 2EQLS10 4SO40C.308

All copyrights are owned by Barlow Tyrie Limited, any infringements of our copyright by any party will actively pursued.

The Barlow Tyrie logo and Elephant design are Registered Trade Marks of Barlow Tyrie Limited.

Whilst great care is taken to reproduce the fabric colours as accurately as possible, it should be noted that due to the limitations of the printing process, the colours illustrated should only be used as a guide.

Barlow Tyrie Limited reserves the right to alter specifications without notice.

Product dimensions and weights are approximate.

This publication has been designed and produced by Barlow Tyrie Limited.

Photography: The Photographic Workshop
Pre Press: Zebra
Printed by: Körner Rotationsdruck

available worldwide



Barlow Tyrie Limited
Braintree
Essex CM7 2RN England

t: + 44 (0)1376 557 600
f: + 44 (0)870 460 1100

Barlow Tyrie Inc
1263 Glen Avenue Suite 230
Moorestown
NJ 08057 - 8101 USA

t: + 1 856 273 7878
f: + 1 856 273 9199

www.teak.com



BARLOW TYRIE

quality outdoor furniture since 1920

Fachhändler-Preisliste September 2010

Saison 2011

Artikelnr.	Produkt	Verkauf € einschl. MwSt.
------------	---------	-----------------------------

Teakholzkollektion

Adirondack

*1ADA	Armlehnstuhl	700
*1ADFR	Fußbank	295
*2AD	62cm Rechteckiger Beistelltisch (Höhe 39cm)	255

Apex

1APA	Armlehnstuhl	630
*2AP21	210cm Rechteckiger Esstisch	2.850
*2APX39	390cm Rechteckiger Ausziehbarer Esstisch	5.995

Ascot Klappbar

1AS	Stuhl	500
1ASC	Armlehnstuhl	620
1ASF5	Fußbank - Beistelltisch	215
1ASR	Liegestuhl mit hoher Rückenlehne	840
1REFS	Liegestuhl-Fußbank/Beistelltisch (für 1ASR)	280
1RET	Anhängetisch (für 1ASR)	60
2AS11	110cm Ø Klappstisch	740
2AS13	130cm Ø Klappstisch	870

Caisse Versailles

*3CV45	Pflanzenkübel 45 x 45cm	520
*3CV60	Pflanzenkübel 60 x 60cm	820

Capri Liegen

*1CAB	Base	690
*1CAS	Standard	900
*1CAU	Ultra	1.595
1CAT	Anhängetisch (für 1CAS)	65
1CBC	Polierte Messing-Clips nur (für 1CAB)	25

Commodore® Klappbar

1CO	Liegestuhl - mit 52cm Fußstütze	1.400
1CO67W	Liegestuhl - mit 67cm Fußstütze und Teakholzrädern	1.500
1COC	Liegestuhl - mit hoher Rückenlehne	980

Crichton

*2CR	Barwagen	1.550
3ST	Teak Tablett 36 x 54cm	100

Felsted

1FEA	Armlehnstuhl	495
1FE12	120cm Bank	740
1FE15	150cm Bank	850
1FEFS	Fußbank - Beistelltisch	225

Glenham®

1GLA	Armlehnstuhl	620
1GL15	150cm Bank	1.040
1GL18	180cm Bank	1.295
1GL24	240cm Bank	1.800
1GLJA	Kindersessel	285
1GLJ2	Kinderbank	370
1GL18CL	Eckbank 180cm - links	1.370
1GL18CR	Eckbank 180cm - rechts	1.370
1GLSC	Runde Baumbank (Preis pro Hälfte)	3.600
1GLHE	Hexagon-Baumbank (Preis pro Hälfte)	2.400
1GLR28	Gerundeter Sitz 285cm Radius	2.850
1GLR28L	Gerundeter Sitz 285cm Radius - links	2.750
1GLR28R	Gerundeter Sitz 285cm Radius - rechts	2.750
1GLR28C	Gerundeter Sitz 285cm Radius - Mittelteil	2.600

Haven einschließlich Kissen

Erweitern Sie bei Bestellungen der Reihe Haven Deep Seating bitte die Artikelnummer um den Farbcode für das Polster. Siehe Seite 6

*1HADA	Deep Seating Armlehnstuhl	1.485
*1HADMC	Deep Seating Eckeinheit	1.540
*1HADML	Deep Seating Linkes Ende	1.160
*1HADMR	Deep Seating Rechtes Ende	1.160
*1HADMM	Deep Seating Mittelstück	1.025
*1HAO	Fußhocker	690
*2HACC10	100cm Runder Beistelltisch (Höhe 48cm)	780
*2HASC10	100cm Eckiger Beistelltisch (Höhe 48cm)	610

Horizon

1HOAS.T	Stapelbarer Armlehnstuhl - Teakholz (nur als Paar erhältlich, Stückpreis)	495
---------	--	------------

Fügen Sie bei der Bestellung der folgenden Produkte bitte an die Artikelnummer den Zusatzcode für die Textilene-Stofffarbe an .500 = Charcoal .501 = White

.502 = Titanium .503 = Aquamarine .504 = Platinium

1HOAS	Stapelbarer Armlehnstuhl - Bespannung (nur als Paar erhältlich, Stückpreis)	520
1HOF	Klappstuhl - Bespannung	375
1HOCF	Klappbarer Armlehnstuhl - Bespannung	475
1HOR	Liegestuhl mit hoher Rückenlehne - Bespannung	695

Artikelnr.	Produkt	Verkauf € einschl. MwSt.
------------	---------	-----------------------------

Teakholzkollektion

Horizon Fortsetzung

1HOL	Liege - Bespannung	1.090
*1LSS	Sonnendach für Liege	110
*2HOC15	150cm Ø Esstisch	1.550
*2HOC18	180cm Ø Esstisch	2.050

Linear

1LIA	Armlehnstuhl	495
------	--------------	------------

London

1LOA	Armlehnstuhl	670
1LO15	150cm Bank	1.070
1LO18	180cm Bank	1.370

Mission einschließlich Kissen

Erweitern Sie bei Bestellungen der Reihe Mission bitte die Artikelnummer um den Farbcode für das Polster. Siehe Seite 6

*1MIA	Armlehnstuhl	1.200
1MIF5	Fußbank	310
2MIL06	60cm Eckiger Beistelltisch (Höhe 39cm)	410

Monaco

*1MOA	Armlehnstuhl	620
*1MO	Stuhl	560
*1MO12	120cm Bank	1.095
*1MO15	150cm Bank	1.250
*1MOSW15	150cm Schaukelbank	1.450
1MOL	Liege	1.740
1MOF	Klappstuhl	400
1MOCF	Klappbarer Armlehnstuhl	500
*1MOH	Bar-Stuhl	690
*1MOCH	Bar-Stuhl mit Armlehne	750
*2MOL04	40cm Eckiger Beistelltisch (Höhe 39cm)	205
*2MOL06	60cm Eckiger Beistelltisch (Höhe 39cm)	310
*2MOL10	100cm Rechteckiger Beistelltisch (Höhe 39cm)	440
*2MOL15	150cm Rechteckiger Beistelltisch (Höhe 40cm)	930
*2MO15	150cm Rechteckiger Esstisch	980
*2MOX24	240cm Rechteckiger Ausziehbarer Esstisch	1.280

Newport

*1NER	Schaukelstuhl
-------	---------------

Provence

*1PRA	Armlehnstuhl	460
*1PR	Stuhl	395

Reims

3RE	Getränketruhe	1.995
-----	---------------	--------------

Rothesay

1ROA	Armlehnstuhl	995
1RO18	180cm Bank	1.680
1RO24	240cm Bank	2.250

Safari® Klappbar

Bitte geben Sie unseren Farbenzusatz bei der Bestellung an.

.200 = Forest Green .201 = White Sand .204 = Pepper
.205 = Classic Blue .207 = Spring

1SA	Armlehnstuhl	410
1SAT	Anhängetisch (für 1SA)	70
2SA	68cm Klappstisch, rechteckig	340

Sissinghurst

1SI	195cm Bank	2.100
-----	------------	--------------

Aufbewahrungstruhe

*3SC11	72 x 114 x 63cm	2.500
*3SC15	72 x 157 x 84cm	3.450

Waveney

1WAA	Armlehnstuhl	510
1WA12	120cm Bank	795
1WA15	150cm Bank	895

Wimbledon

1WI12	120cm Lehnenlose Bank	510
1WI15	150cm Lehnenlose Bank	580
1WI18	180cm Lehnenlose Bank	795

Artikelnr.	Produkt	Verkauf € einschl. MwSt.
------------	---------	-----------------------------

Teakholztische

Arundel		
*2AR09	90cm Eckiger Esstisch	870
*2AR18	180cm Rechteckiger Esstisch	1.495
*2AR24	240cm Rechteckiger Esstisch	2.300
*2ARX28	285cm Rechteckiger Ausziehbarer Esstisch	3.200
Balmoral		
*2BA11	110cm Ø Esstisch	995
*2BA13	130cm Ø Esstisch	1.230
Cambridge		
*2CA	76cm Rechteckiger Beistelltisch (Höhe 36cm)	250
*2CAJ	76cm Rechteckiger Kinderesstisch (Höhe 48cm)	295
Colchester		
*2COL	54cm Eckiger Beistelltisch - niedrig (Höhe 40cm)	275
*2COH	54cm Eckiger Beistelltisch - hoch (Höhe 54cm)	300
Drummond		
*2DR15	150cm Ø Esstisch	1.930
*2DR18	185cm Ø Esstisch	2.500
*2LS07	75cm Ø Lazy Susan (für 2DR15, 2WIC15)	310
*2LS11	110cm Ø Lazy Susan (für 2DR18)	530
Edinburgh		
*2EDL09	90cm Ø Beistelltisch (Höhe 42cm)	690
*2ED09	90cm Ø Esstisch	740
*2EDH09	90cm Ø Bar-Tisch (Höhe 98.5cm)	830
Metzo		
*2ME09T	90cm Eckiger Esstisch	920
*2ME15T	150cm Rechteckiger Esstisch	1.230
Stirling		
*2ST20	200cm Ovaler Esstisch	1.670
*2STX32	320cm Ovaler Ausziehbarer Esstisch	3.350
Windsor		
*2WI08	82cm Eckiger Esstisch	580
*2WI12	120cm Rechteckiger Esstisch	695
*2WI15	150cm Rechteckiger Esstisch	780
*2WIX23	235cm Rechteckiger Ausziehbarer Esstisch	1.880
*2WIC15	150cm Ø Esstisch	1.100

Artikelnr.	Produkt	Verkauf € einschl. MwSt.
------------	---------	-----------------------------

Aluminiumkollektion

Aura				
stapelbarer Armlehnstuhl, nur im Viererset erhältlich, Einzelpreis				
		Gestell	Bespannung	
1AUA.01.500	Armlehnstuhl	Graphite	- Charcoal	310
1AUA.01.502	Armlehnstuhl	Graphite	- Titanium	310
1AUA.01.504	Armlehnstuhl	Graphite	- Platinum	310
1AUA.02.501	Armlehnstuhl	Arctic White	- White	310
1AUA.02.503	Armlehnstuhl	Arctic White	- Aquamarine	310
Erweitern Sie bei Bestellung von Aura -Tischen bitte die Artikelnummer um den Farbcode für das Gestell .01 = Graphite .02 = Arctic White e.g. 2AU09.01				
*2AU09	90cm Eckiger Esstisch			640
*2AU15	150cm Rechteckiger Esstisch			795
*2AU20	200cm Rechteckiger Esstisch			960
Eclipse				
Stapelbarer Armlehnstuhl und Liege.				
Armlehnstuhl, nur im Viererset erhältlich, Einzelpreis				
		Gestell	Bespannung	
1ECA.01.500	Armlehnstuhl	Graphite	- Charcoal	380
1ECA.01.502	Armlehnstuhl	Graphite	- Titanium	380
1ECA.01.504	Armlehnstuhl	Graphite	- Platinum	380
1ECA.02.501	Armlehnstuhl	Arctic White	- White	380
1ECA.02.503	Armlehnstuhl	Arctic White	- Aquamarine	380
1ECA.03.504	Armlehnstuhl	Quicksilver	- Platinum	380
1ECL.01.500	Liege	Graphite	- Charcoal	1.040
1ECL.01.502	Liege	Graphite	- Titanium	1.040
1ECL.01.504	Liege	Graphite	- Platinum	1.040
1ECL.02.501	Liege	Arctic White	- White	1.040
1ECL.02.503	Liege	Arctic White	- Aquamarine	1.040
1ECL.03.504	Liege	Quicksilver	- Platinum	1.040
Erweitern Sie bei Bestellung von Eclipse -Tischen bitte die Artikelnummer um den Farbcode für das Gestell .01 = Graphite .02 = Arctic White .03 = Quicksilver e.g. 2EC20.01				
*2ECLT	49cm Rechteckiger Beistelltisch für Liegestuhl			175
*2ECC12	120cm Ø Esstisch			930
*2EC20	200cm Rechteckiger Esstisch			1.220
Loop				
Stapelbarer Armlehnstuhl und Liege.				
Armlehnstuhl, nur im Viererset erhältlich, Einzelpreis				
		Gestell	Bespannung	
1LPA.01.500	Armlehnstuhl	Graphite	- Charcoal	275
1LPA.01.502	Armlehnstuhl	Graphite	- Titanium	275
1LPA.01.504	Armlehnstuhl	Graphite	- Platinum	275
1LPA.02.501	Armlehnstuhl	Arctic White	- White	275
1LPA.03.504	Armlehnstuhl	Quicksilver	- Platinum	275
1LPL.01.500	Liege	Graphite	- Charcoal	780
1LPL.01.502	Liege	Graphite	- Titanium	780
1LPL.01.504	Liege	Graphite	- Platinum	780
1LPL.02.501	Liege	Arctic White	- White	780
1LPL.03.504	Liege	Quicksilver	- Platinum	780
Erweitern Sie bei Bestellungen optionaler Armlehnen bitte die Artikelnummer um den Farbcode: .01 = Graphite .02 = Arctic White .03 = Quicksilver				
1LPLA	Optionale Armlehnen (für 1LPL)			140
Erweitern Sie bei Bestellung von Loop-Tischen bitte die Artikelnummer um den Farbcode für das Gestell .01 = Graphite .02 = Arctic White .03 = Quicksilver e.g. 2LP16.01				
*2LPLT	Eckiger Beistelltisch für Liegestuhl			255
*2LP16	160cm Rechteckiger Esstisch			1.095
Edelstahlkollektion				
Equinox				
stapelbarer Stuhl ohne Armlehne, Armlehnstuhl und Liegestuhl.				
Stühle mit und ohne Armlehne, nur paarweise erhältlich, Einzelpreis				
		Armlehne	Bespannung	
1EQ.500	Stuhl		- Charcoal	430
1EQ.501	Stuhl		- White	430
1EQ.502	Stuhl		- Titanium	430
1EQ.504	Stuhl		- Platinum	430
1EQ.503	Stuhl		- Aquamarine	430
1EQA.01.500	Armlehnstuhl	Graphite	- Charcoal	460
1EQA.01.502	Armlehnstuhl	Graphite	- Titanium	460
1EQA.01.504	Armlehnstuhl	Graphite	- Platinum	460
1EQA.02.501	Armlehnstuhl	Arctic White	- White	460
1EQA.02.503	Armlehnstuhl	Arctic White	- Aquamarine	460
1EQL.01.500	Liege	Graphite	- Charcoal	1.150
1EQL.01.502	Liege	Graphite	- Titanium	1.150
1EQL.01.504	Liege	Graphite	- Platinum	1.150
1EQL.02.501	Liege	Arctic White	- White	1.150
1EQL.02.503	Liege	Arctic White	- Aquamarine	1.150

Artikelnr.	Produkt	Verkauf € einschl. MwSt.
------------	---------	-----------------------------

Edelstahlkollektion Fortsetzung

Equinox

Erweitern Sie bei Bestellungen des Sonnendachs für die Liege bitte die Artikelnummer um den Textile-Farbcode: .500 = Charcoal .501 = White .502 = Titanium
.503 = Aquamarine .504 = Platinum

1EQ.T	Stuhl - Teakholz	495
1EQA.T	Armlehnstuhl - Teakholz	520
1EQL.T	Liege - Teakholz	1.260
*1LSS	Sonnendach für Liege (Für 1EQL)	110
*1EQ13	135cm Lehnenlose Bank	630

Equinox Tables mit Teakholzplatten

*2EQLT	49cm Rechteckiger Beistelltisch für Liegestuhl	260
*2EQL04	40cm Eckiger Beistelltisch (Höhe 39cm)	330
*2EQL06	60cm Eckiger Beistelltisch (Höhe 39cm)	410
*2EQL10	100cm Rechteckiger Beistelltisch (Höhe 39cm)	540
*2EQ10	90cm x 100cm Rechteckiger Esstisch	950
*2EQ15	150cm Rechteckiger Esstisch	1.195
*2EQ22	220cm Rechteckiger Esstisch	1.560
*2EQX23	230cm Rechteckiger Ausziehbarer Esstisch	1.740
*2EQCC10	100cm Ø Beistelltisch (Höhe 48cm)	1.070
*2EQSC10	100cm Eckiger Beistelltisch (Höhe 48cm)	880
*2EQC07	70cm Ø Bistro Tisch	510
*2EQC10	100cm Ø Pedestal Esstisch	1.010
*2EQC15S	150cm Ø Esstisch	1.840
*2EQC18S	180cm Ø Esstisch	2.300
2EQLS07	70cm Ø Lazy Susan (für 2EQC15)	410
2EQLS10	100cm Ø Lazy Susan (für 2EQC18)	650
*2EQS	114cm Rechteckiger Serviertisch (Höhe 85cm)	1.095

Equinox Tables mit Platten aus HPL (Hochdrucklaminat) in Slate Grey

*2EQ09.700	90cm Eckiger Esstisch	895
*2EQ15.700	150cm Rechteckiger Esstisch	1.270
*2EQ20.700	200cm Rechteckiger Esstisch	1.795
*2EQC15.700	150cm Ø Esstisch mit 69.5cm Ø Lazy Susan	2.650
*2EQC18.700	180cm Ø Esstisch mit 84.5cm Ø Lazy Susan	3.400

Equinox High Dining

1EQH.T	Bar - Stuhl - Teakholz	450
1EQHC.T	Bar - Stuhl mit Armlehne - Teakholz	520
1EQHS.T	Bar - Hocker - Teakholz	350
*2EQCH07	70cm Ø Bar-Tisch (Höhe 98.5cm)	560
*2EQCH10	100cm Ø Bar-Tisch (Höhe 98.5cm)	1.050

Equinox Deep Seating einschließlich Kissen

Erweitern Sie bei Bestellungen der Reihe Equinox Deep Seating bitte die Artikelnummer um den Farbcode für das Polster: Siehe Seite 6

1EQDA	Deep Seating Armessel	1.200
1EQD2	Deep Seating Zweisitzersofa	1.955
1EQD3	Deep Seating Dreisitzersofa	2.880
1EQDO	Deep Seating Fußhocker	700

Mercury stapelbare Armlehnstühle, nur im Vierer-set erhältlich, Einzelpreis

	Armlehne	Bespannung	
1MEA.01.500	Armlehnstuhl	Graphite - Charcoal	395
1MEA.01.502	Armlehnstuhl	Graphite - Titanium	395
1MEA.01.504	Armlehnstuhl	Graphite - Platinum	395
1MEA.02.501	Armlehnstuhl	Arctic White - White	395
1MEA.02.503	Armlehnstuhl	Arctic White - Aquamarine	395
1MEA.500	Armlehnstuhl	Teakholz - Charcoal	395
1MEA.501	Armlehnstuhl	Teakholz - White	395
1MEA.502	Armlehnstuhl	Teakholz - Titanium	395
1MEA.504	Armlehnstuhl	Teakholz - Platinum	395

Erweitern Sie bei Bestellungen des Mercury-Tisches bitte die Artikelnummer um den Farbcode für die Glasplatte: .604 = Sea Ice .605 = Platinum .606 = Charcoal

*2MEC12	120cm Ø Esstisch	895
*2ME22	220cm Rechteckiger Esstisch	1.740
*2MES	120cm Rechteckiger Serviertisch (mit Keramikplatte in Slate Grey)	2.450

Artikelnr.	Produkt	Verkauf € einschl. MwSt.
------------	---------	-----------------------------

Edelstahlkollektion Fortsetzung

Quattro

stapelbarer Armlehnstuhl und Liegestuhl, armlehnstühle, nur im Vierer-set erhältlich, Einzelpreis

	Armlehne	Bespannung	
1QUA.01.500	Armlehnstuhl	Graphite - Charcoal	330
1QUA.01.502	Armlehnstuhl	Graphite - Titanium	330
1QUA.01.504	Armlehnstuhl	Graphite - Platinum	330
1QUA.02.501	Armlehnstuhl	Arctic White - White	330
1QUA.02.503	Armlehnstuhl	Arctic White - Aquamarine	330
1QUA.500	Armlehnstuhl	Teakholz - Charcoal	330
1QUA.502	Armlehnstuhl	Teakholz - Titanium	330
1QUA.504	Armlehnstuhl	Teakholz - Platinum	330
1QUA.501	Armlehnstuhl	Teakholz - White	330
1QUA.503	Armlehnstuhl	Teakholz - Aquamarine	330
1QUL.500	Liege	- Charcoal	750
1QUL.501	Liege	- Titanium	750
1QUL.502	Liege	- Titanium	750
1QUL.504	Liege	- Platinum	750
1QUL.503	Liege	- Aquamarine	750

Erweitern Sie bei Bestellungen des Sonnendachs für die Liege bitte die Artikelnummer um den Textile-Farbcode: .500 = Charcoal .501 = White .502 = Titanium
.503 = Aquamarine .504 = Platinum

*1LSS	Sonnendach für Liege (Für 1QUL)	110
Alle Quattro-Tische verfügen über Platten aus HPL (Hochdrucklaminat) in Slate Grey		
*2QULT.700	Beistelltisch für Liegestuhl	155
*2QU10.700	100cm Eckiger Esstisch	740
*2QU20.700	200cm Rechteckiger Esstisch	1.295

Textilkollektion

Arizona einschließlich Kissen Farbe - Sahara und Java

Erweitern Sie bei Bestellungen der Reihe Arizona bitte die Artikelnummer um den Farbcode für das Polster: Siehe Seite 6

Sahara	Java		
601352 - 601362	76cm Eckiger Fußhocker		670
601350 - 601360	104cm Eckiger Fußhocker		975
601351 - 601361	Armlehnstuhl		1.540
601354 - 601364	Linkes Ende		1.440
601355 - 601365	Rechtes Ende		1.440
601356 - 601366	Eckeinheit		1.600
601357 - 601367	Mittelstück		1.250
601650 - 601660	75cm Eckiger Beistelltisch (Höhe 46cm)		570
601651 - 601661	120cm Rechteckiger Beistelltisch (Höhe 46cm)		710
601652 - 601662	47cm Abschluss Tisch (Höhe 54cm)		460

Dune einschließlich Kissen Farbe - Straw und Java

Erweitern Sie bei Bestellungen der Reihe Dune bitte die Artikelnummer um den Farbcode für das Polster: Siehe Seite 6

Straw	Java		
602700 - 602750	Ruheliege und Hocker		3.665
602351 - 602361	Armlehnstuhl		1.360
602352 - 602362	Zweisitzersofa		2.280
602650 - 602660	100cm Ø Beistelltisch (Höhe 48cm)		840

Nevada Kissen nicht inbegriffen Farbe - Cinnamon

Erweitern Sie bei Bestellungen von Polstern für den Armlehnstuhl Nevada bitte die Artikelnummer um den Farbcode: Siehe Seite 6

605100	Armlehnstuhl	420
--------	--------------	------------

Nevada Deep Seating einschließlich Kissen Farbe - Cinnamon

Erweitern Sie bei Bestellungen von Polstern für den Armlehnstuhl Nevada bitte die Artikelnummer um den Farbcode: Siehe Seite 6

605351	Deep Seating Armlehnstuhl	870
605350	Deep Seating Fußhocker	485
605353	Deep Seating Dreisitzersofa	2.225
605470	Deep Seating Liege	1.450

Savannah Kissen nicht inbegriffen Farbe - Java

Erweitern Sie bei Bestellungen der Reihe Savannah bitte die Artikelnummer um den Farbcode für das Polster: Siehe Seite 6

603100	Armlehnstuhl	430
603171	Stuhl	330
603522	120cm Ø Esstisch (mit Glasplatte)	960
603524	150cm Ø Esstisch (mit Glasplatte)	1.350
603565	200cm Rechteckiger Esstisch (mit Glasplatte)	1.530
603650	95cm Rechteckiger Beistelltisch (mit Glasplatte)	510
603651	150cm Rechteckiger Beistelltisch (mit Glasplatte)	930
603670	40cm Abschluss Tisch (mit Glasplatte)	310

Artikelnr.	Produkt	Verkauf € einschl. MwSt.
------------	---------	-----------------------------

Textilkollektion Fortsetzung

Savannah Deep Seating einschließlich Kissen Farbe - Java

603350	Deep Seating Fußhocker	555
603351	Deep Seating Armlehnstuhl	995
603352	Deep Seating Zweisitzersofa	1.630
603353	Deep Seating Dreisitzersofa	2.230
603470	Deep Seating Liege <small>(Kissen nicht inbegriffen)</small>	1.140
603700	Beistelltisch für Liegestuhl <small>(mit Glasplatte)</small>	270

Pavillions

Les Pavillions sind in folgenden Farben erhältlich. Erweitern Sie bitte die Artikelnummer um den Farbcode für den Stoff. 909050.1275 .1275 = Stone .4781 = Chocolate .4642 = Oyster .4651 = Silver .4604 = White

3.66m x 3m

9011210	Gestell für festes Dach	3.885
<i>Umfasst:</i>		
9021210	Sunbrella-Dach	
909050	Eckbinden	
909010	Eckbehänge	
<i>Optionale Extras:</i>		
9031210	Sunbrella-Vorhänge	2.200
9041210	Maschenvorhänge	1.295
909080	Einfache Seitenteile. Acht	1.495

3.66m x 4.5m

9011215	Gestell für festes Dach	6.105
<i>Umfasst:</i>		
9021215	Sunbrella-Dach	
909050	Eckbinden	
909020	Eckbehänge	
<i>Optionale Extras:</i>		
9031215	Sunbrella-Vorhänge	2.850
9041215	Maschenvorhänge	1.495
909080	Einfache Seitenteile. Acht	1.495

3.66m x 6m

9011220	Gestell für festes Dach	7.205
<i>Umfasst:</i>		
9021220	Sunbrella-Dach	
909050	Eckbinden	
909020	Eckbehänge	
<i>Optionale Extras:</i>		
9031220	Sunbrella-Vorhänge	3.600
9041220	Maschenvorhänge	1.795
909080	Einfache Seitenteile. Acht	1.495

3.66m x 3m Cabrio

9111210	Gestell für Cabriodach	6.755
<i>Umfasst:</i>		
9121210	Sunbrella Dachöffnung	
909050	Eckbinden	
909020	Eckbehänge	
<i>Optionale Extras:</i>		
9031210	Sunbrella-Vorhänge	2.200
9041210	Maschenvorhänge	1.295
909080	Einfache Seitenteile. Acht	1.495
913000	Heizungs- und Beleuchtungseinheit	1.050
913010	Bodenverankerung - Holzboden <small>(pro Stück)</small>	6
913011	Bodenverankerung - Steinboden <small>(pro Stück)</small>	12
913012	Verankerungssystem Permo® Lock <small>(4er-Packung)</small>	380

Artikelnr.	Produkt	Verkauf € einschl. MwSt.
------------	---------	-----------------------------

Sonnenschirme

Bei der Bestellung von Sonnenschirme bitte Code für Farbe an Artikelnummer anfügen. .300 = Forest Green .306 = Oyster .308 = Black

Siena	Holzstange von 38mm Ø und Chromausstattung	
4SI25C	Sonnenschirme Rund 2.5m Ø	640

Verona	Holzstange von 48mm Ø und Chromausstattung	
4VE30C	Sonnenschirme Rund 3m Ø	1.070
4VE30R	Sonnenschirme Rechteckig 3 x 2.2m	1.050

Milano	Holzstange von 61mm Ø und Messingausstattung	
4MI35C	Sonnenschirme Rund 3.5m Ø	1.260
4MI40C	Sonnenschirme Rund 4m Ø	1.320
4MI35R	Sonnenschirme Rechteckig 3.5 x 2.5m	1.280

Sorrento	Holzstange von 61mm Ø und Chromausstattung	
4SO35C	Sonnenschirme Rund 3.5m Ø	1.250
4SO40C	Sonnenschirme Rund 4m Ø	1.350
4SO35R	Sonnenschirme Rechteckig 3.5 x 2.5m	1.350

Nachhülle		
4PSCS	Für Siena-Sonnenschirme	85
4PSCS	Für Verona, Milano und Sorrento-Sonnenschirme	130

Sonnenschirmständer

4PBS	Für Siena-Sonnenschirme	230
4PBM	Für Verona-Sonnenschirme	395
4PBL	Für Milano und Sorrento-Sonnenschirme	410

Sonnenschirmsockel - Tisch mit Säulenfuß

4PBPS	Nur Sockel (für 2EQC07 & 2EQCH07)	160
4PBPL	Nur Sockel (für 2EQC10 & 2EQCH10)	310

Sockel für freistehenden Sonnenschirm

4PBFP	Nur Sockel	510
4PBFTS	Kleiner Innendurchmesser <small>(für Siena)</small>	75
4PBFTM	Mittlerer Innendurchmesser <small>(für Verona)</small>	99
4PBFTL	Großer Innendurchmesser <small>(für Milano, Sorrento)</small>	105

Messingringe zur Reduzierung des Schirmstangenlochs

4PR.00	Sonnenschirm-Locheinsatz	38
4PR.38	Für Siena-Sonnenschirme	40
4PR.48	Für Verona-Sonnenschirme	40
4PR.61	Für Milano und Sorrento-Sonnenschirme	40

Edelstahlringe zur Reduzierung des Schirmstangenlochs

4PRSS.00	Sonnenschirm-Locheinsatz	43
4PRSS.38	Für Siena-Sonnenschirme	44
4PRSS.48	Für Verona-Sonnenschirme	44
4PRSS.61	Für Milano und Sorrento-Sonnenschirme	44

Pflegeprodukte

4TC	Teak Cleaner	1litre	25
4TSG	Teak Stain Guard	1litre	40
4TCG	Teak Colour Guard	1litre	35
4SSCG	Stainless Steel Clean & Guard	1litre	35
4AC	Powder Coated Aluminium Cleaner	1litre	20
4WTC	Textile & Woven Cleaner	1litre	25
4FC	Fabric Cleaner	1litre	20
4FWG	Fabric Weather Guard	1litre	40
4TO	Teak Oil <small>(Verkauft als Kasten mit 12 x 500ml Plastikflaschen)</small>	500ml	10
4WS	Anti Wasp Solution	1litre	30

Inschriften

5CA	Geschnitzte Seriffbuchstaben <small>(Stückpreis)</small>	3
5BPS	Bronzeschild	90
5BPL	Mit Buchstaben <small>(Stückpreis)</small>	3

Sonstiges

4FI	Befestigungseisen (Diebstahlsicherung) <small>(Stückpreis)</small>	12
4SF	Sicherheitsbeschläge aus poliertem Messing (x4)	105

Artikelnr.	Produkt	Verkauf € einschl. MwSt.
Kissen		
Bei der Bestellung von Sitzkissen bitte Code für Kissenfarbe an Artikelnummer anfügen		
.5446 = Forest Green	.5404 = White Sand	.5476 = Pepper
.5408 = Black	.3705 = Charcoal	.5470 = Walnut
.5424 = Sky Blue	.5629 = Sky Blue Stripe	.3728 = Paris Red
.3747 = Macaw Stripe	.3756 = Lead Chiné	.3778 = Quadri Grey
800001	Armlehnstuhl 1FEA, 1GLA, 1LOA, 1MOA, 1PRA, 1WAA	80
800002	Liegestuhl mit hoher Rückenlehne 1ASR, 1COC, 1NER	195
800003	Liegestuhl mit hoher Rückenlehne nur Sitzpolster 1ASR, 1COC, 1NER	80
800004	Stuhl 1AS, 1ASC, 1MOF, 1MOCF	75
800005	Stuhl, groß 1EQ.T, 1EQA.T, 1MO, 1MOCH, 1MOH, 1PR	80
800006	Liege 1CAB, 1CAS, 1CAU, 1EQLT, 1MOL	395
800008	Horizon Armlehnstuhl 1HOAS.T	120
800087	Armlehnepolster zum Überziehen 1APA, 1LIA	135
800012	Bank 120cm 1FE12, 1MO12, 1WA12	160
800015	Bank 150cm 1FE15, 1GL15, 1LO15, 1MO15, 1MOSW15, 1WA15	220
800018	Bank 180cm 1GL18, 1LO18	265
800056	Savannah Armlehnstuhl 603100	95
800064	Savannah Stuhl 603171	85
800062	Savannah Liege 603470	395
800066	Liegestuhl mit 52cm Fußstütze 1CO	410
800067	Liegestuhl mit 67cm Fußstütze 1CO67W	430
800080	Nevada Armlehnstuhl 605100	80
800007	Rückenstützkissen 51 x 20cm Alle	55
800050	Sofakissen 50 x 50cm Alle	60
800060	Sofakissen 60 x 60cm Alle	85
800070	Sofakissen 70 x 70cm Alle	100

Allgemeine Geschäftsbedingungen

Barlow Tyrie Limited behält sich das Recht auf Spezifikationsänderungen ohne vorherige Ankündigung vor. Bei Bestellungen bitte Artikelnummer angeben.

Zusammenbau

*Gewisse Montage erforderlich

Baumbänke

Zwei Hälften werden benötigt um eine Baumbank zu vervollständigen. Falls gewünscht, kann jede Hälfte einzeln geliefert werden.

Tische

Tische werden mit einer Halterung für Sonnenschirmstangen in einer Stärke bis 70 mm geliefert. Davon ausgenommen sind der ausziehbare Apex-Esstisch sowie die Tische Mercury und Quattro, die keine Schirmstangenlöcher haben. Die Esstische der Reihe Edinburgh und der Bistrotisch Equinox weisen ein Schirmstangenloch in einer Stärke von 40 mm auf. Zur Verwendung ohne Sonnenschirm wird ein massiver, gut abschließender Einsatz im entsprechenden Material geliefert.

Artikelnr.	Produkt	Pass für	Verkauf € einschl. MwSt.
Möbelbezüge			
400101	Armlehnstuhl Arizona	601351, 601361	170
400102	2-Sitzer-Kombination Arizona	601354 + 601355, 601364 + 601365	240
400103	3-Sitzer-Kombination Arizona	601354 + 601357 + 601355, 601364 + 601367 + 601365	299
400118	Abschlusstisch Arizona	601652, 601662	80
400130	Beistelltisch Arizona, 75cm	601650, 601660	130
400147	Beistelltisch Arizona, 120cm	601651, 601661	135
400501	Polstersessel Nevada	605351	165
400503	3-Sitzer-Sofa Nevada	605353	245
400700	Liege und Hocker Dune	602700, 602750	310
400701	Polstersessel Dune	602351, 602361	220
400702	2-Sitzer-Sofa Dune	602352, 602362	310
400721	Polstersessel mit hoher Lehne	603351, 1ADA, 1HADA, 1MIA	125
400722	2-Sitzer-Sofa mit hoher Lehne	603352	165
400723	3-Sitzer-Sofa mit hoher Lehne	603353	225
400731	Sonnenliegen	Alle Sonnenliegen	175
400741	SPolsterstuhl in Standardhöhe	1EQDA	125
400742	2-Sitzer-Sofa in Standardhöhe	1EQD2, 1HADML + 1HADMR	150
400743	3-Sitzer-Sofa in Standardhöhe	1EQD3, 1HADML + 1HADMM + 1HADMR	225
400751	Tisch, 90 cm zu 120 cm, & 4 Stühle	2ED09, 2EQC10, 2AR09, 2EQ10, 2BA11, 2BA13, 2ECC12, 603522	230
400752	Runder Esstisch, 90 cm hoch, & 4 Stühle	2EDH09, 2EQCH10	370
400754	Runder Esstisch, 150 cm/180 cm, & 8 Stühle	2DR15, 2EQC15S, 2WIC15, 603524, 2DR18, 2EQC18S	290
400765	Rechteckiger Tisch, 150 cm, & 6 Stühle	2AR13, 2ME15T, 2MO15, 2W15, 2EQ15, 2EQX23 (geschl.)	230
400766	Rechteckiger Tisch, 200 cm, & 8 Stühle	2AR18, 2ARX28 (geschl.), 2ST20, 2EQ22, 2EC20, 603565, 604565	360
400767	Rechteckiger Tisch, 320 cm, & 10 Stühle	2STX32 (geschl.)	395
400768	Ausziehtisch Apex mit 14 Stühlen	2APX39	340
400770	Servierwagen und Tische	2CR, 2EQS, 2MES	130
400772	Kleine Aufbewahrungskiste	3SC11	165
400773	Große Aufbewahrungskiste	3SC15	225
400774	Getränktruhe Reims	3RE	90
400781	Runder Beistelltisch	602650, 602660, 2EQCC10, 2HACC10	160
400782	Eckiger Beistelltisch	2EQSC10, 2HASC10	125
400783	Kleiner eckiger Beistelltisch	603650	120
400784	Großer eckiger Beistelltisch	603651	195

Sonnenschirme

Alle Barlow Tyrie Sonnenschirme können über allen unseren normalen Esstischen zusam mengeklappt werden.

Zahlungsbedingungen

Unterliegen unseren normalen Verkaufsbedingungen.

Lieferkosten

Bestellungen unter € 1.000 + € 100

E & OE

Barlow Tyrie Limited Braintree Essex CM7 2RN England
T : + 44 (0)1376 557 600 F : + 44 (0)870 460 1100

www.teak.com

